

Diese Unterlagen sind Eigentum der HOPPE AG, D-35260 Stadtlendorf und urheber- sowie wettbewerbsrechtlich geschützt. Nachbau, Nachdruck, Vervielfältigung, Weitergabe an Dritte sowie jedwede sonstige Verwertung dieser Unterlagen oder Teilen davon sind ohne vorherige schriftliche Zustimmung von HOPPE nicht gestattet.

M43/843KV/843KV/843KS PZ

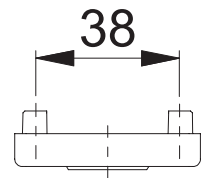
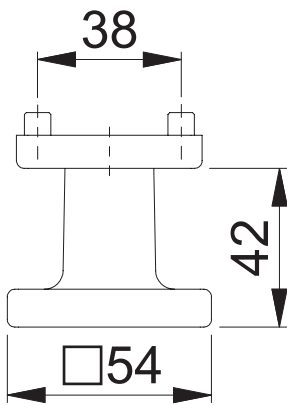
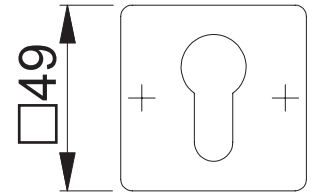
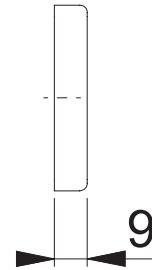
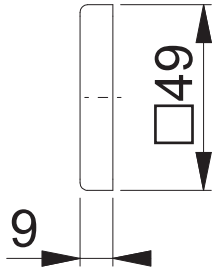
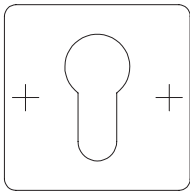
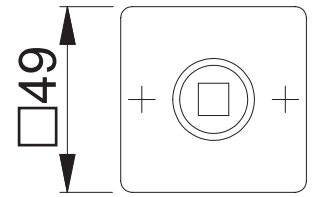
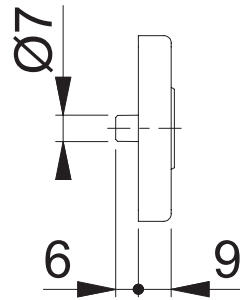
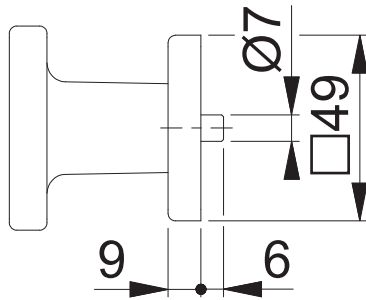
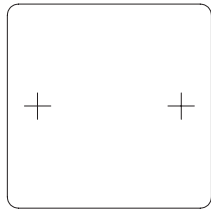

These documents are property of HOPPE AG, D-35260 Stadtlendorf and are protected by both copyright and fair trade law. Any reproduction, reprint, copying, passing on to third parties and whichever use of these documents or parts thereof is prohibited, except with prior written consent of HOPPE.

| | | | | | |
|----------------|----------------|---------------------|----------------------------------|-------|--|
| Maßstab 1:2 | Name Scholz | Datum 14.10.2014 | Zeichnungsnummer c0023116z000 | A4 00 | |
| | Name Scholz | Datum 15.10.2014 | Zeichnungsnummer c1092072g002 | A4 00 | |