

M1628/52/52S PZ (HGI, F-KS)

Bearbeitet / Datum

HH/24.09.24

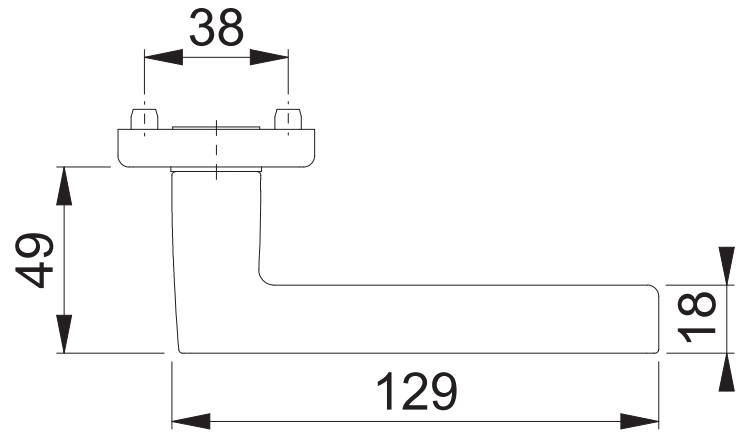
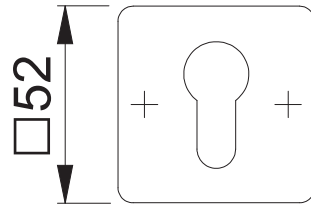
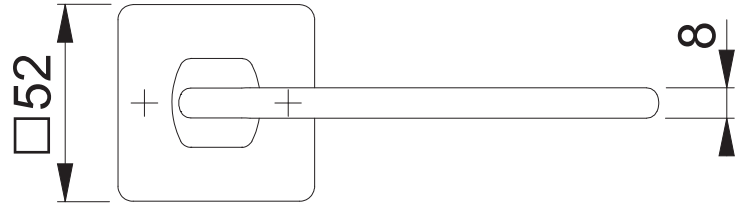
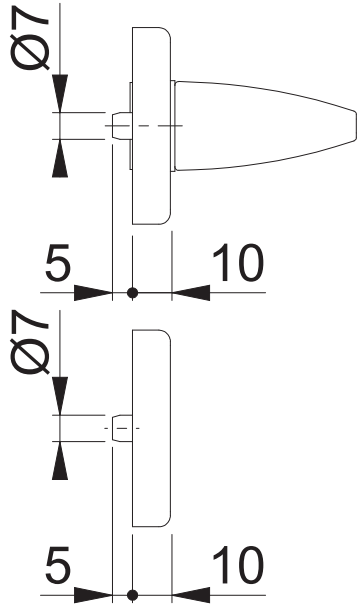

Maßstab 1:2	Name ASC5	Datum 23.09.24	Zeichnungsnummer / Quelle c0023362z001	R 00
Artikel-Schriftfeld-CAD M1628/52/52S			Zeichnungsnummer / Quelle (alt)	

