

M1240/870K/870KS SK/OL (MSK821/MOL45)

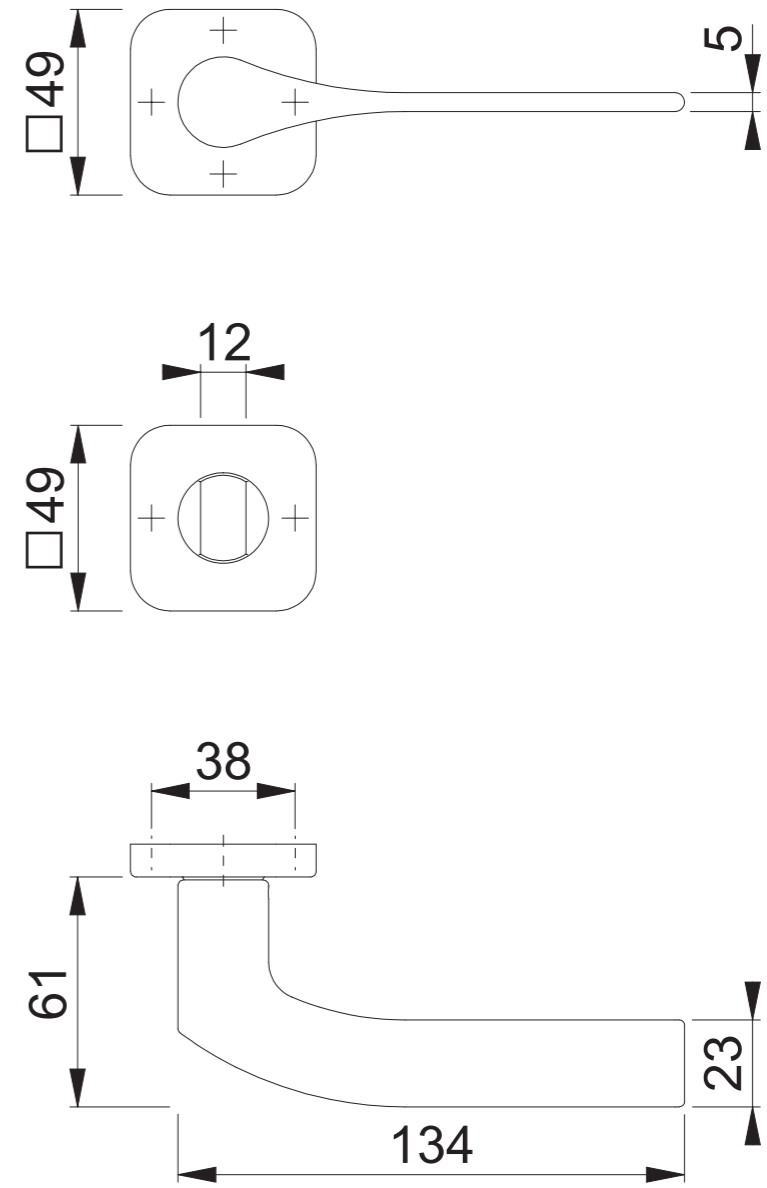
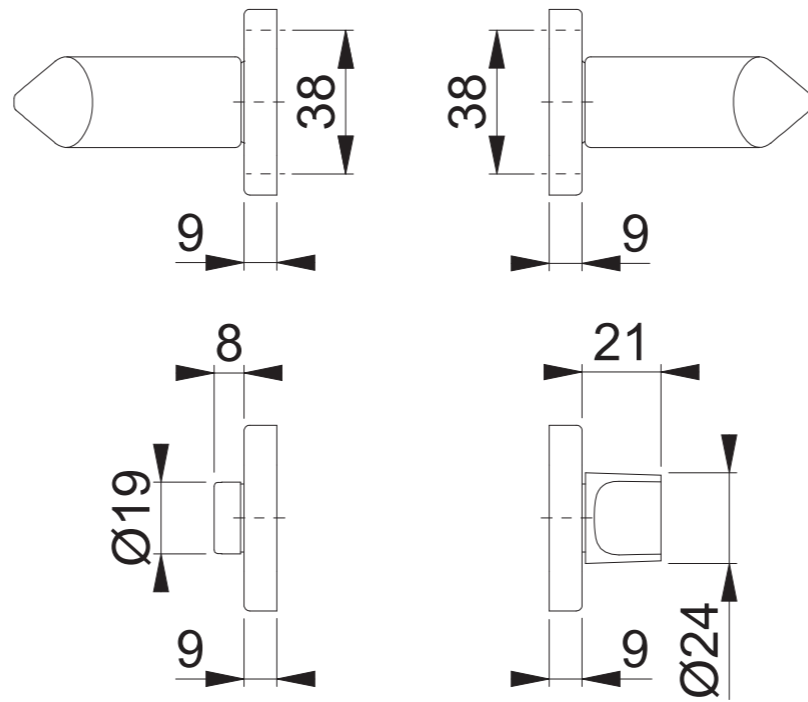
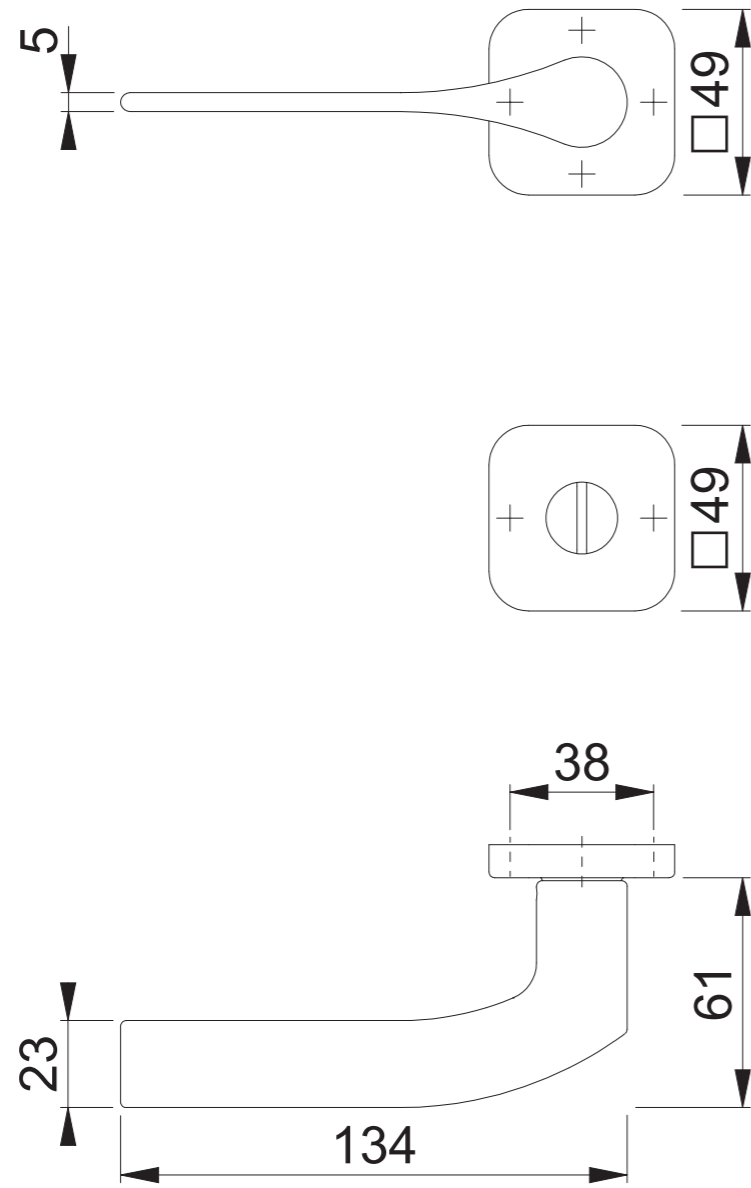

Maßstab 1:2	Name ASC5	Datum 12.07.24	Zeichnungsnummer / Quelle c002-0004808z000	R 00
Artikel-Schriftfeld-CAD M1240/870K/870KS/870KS/870K/1240			Zeichnungsnummer / Quelle (alt)	