

FS-E86G/3332ZA/42H/42HS/1401 PZ ES1/SK2 (E1401F)

Kombi-Schutz

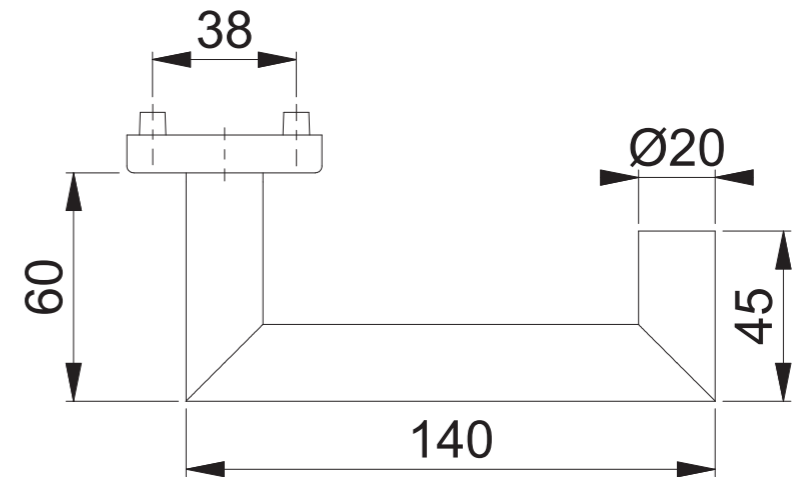
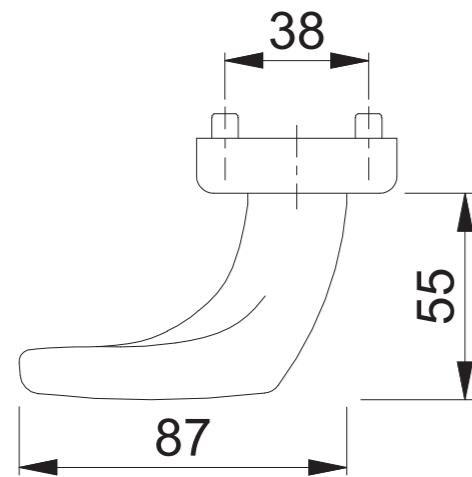
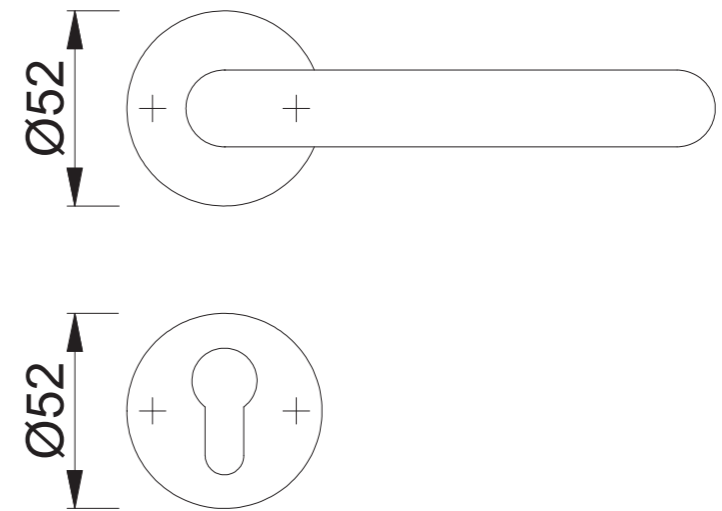
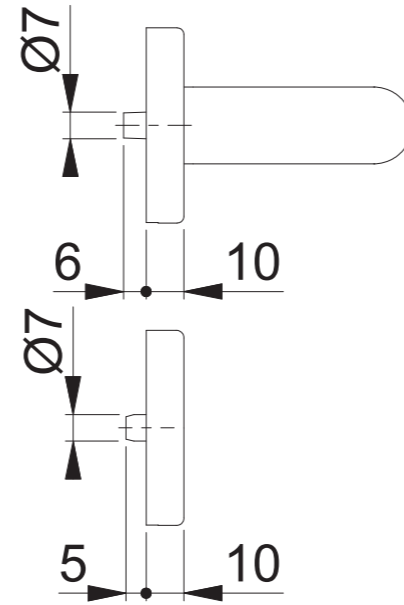
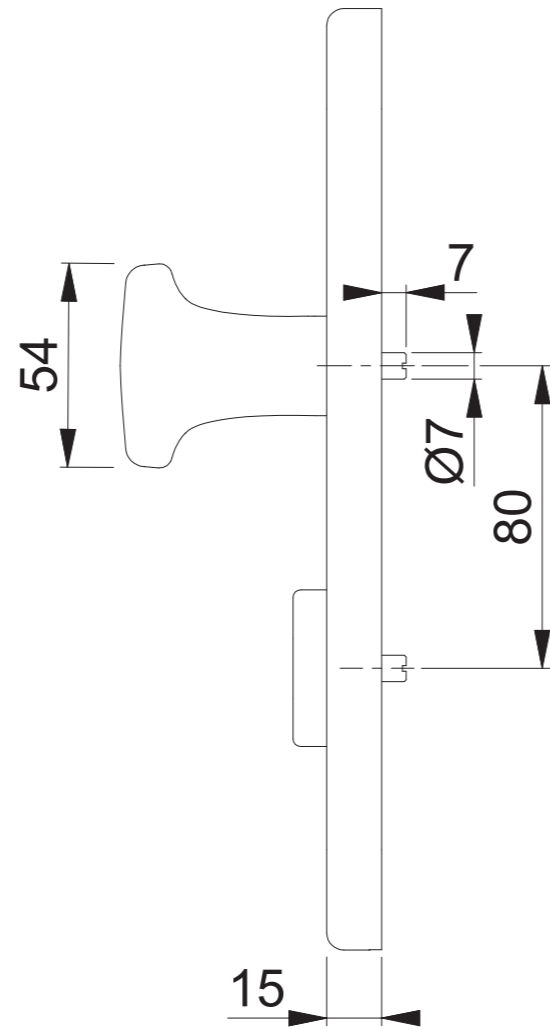
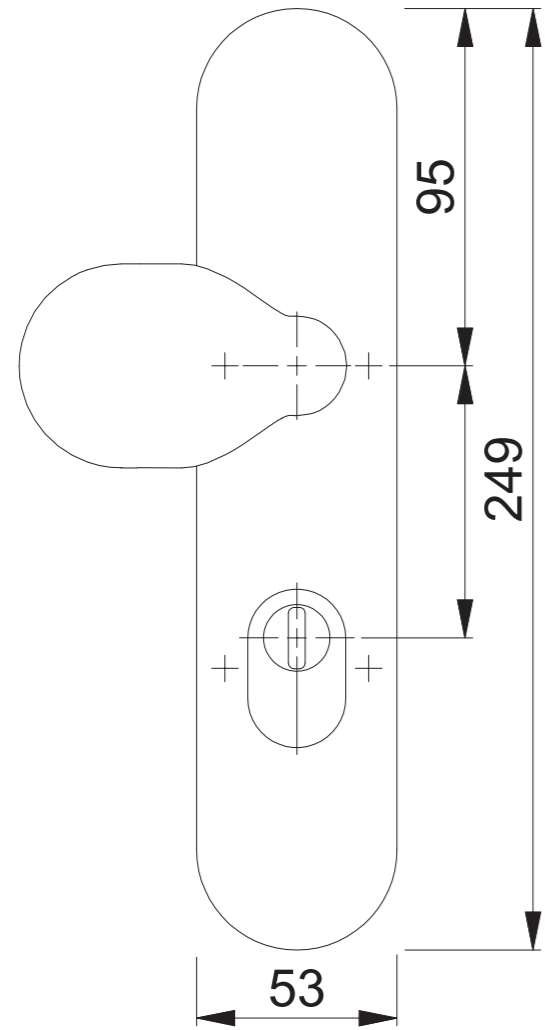

Diese Unterlagen sind Eigentum der HOPPE AG, D-35260 Stadtlendorf und urheber- sowie wettbewerbsrechtlich geschützt. Nachbau, Nachdruck, Vervielfältigung, Weitergabe an Dritte sowie jedwede sonstige Verwertung dieser Unterlagen oder Teilen davon sind ohne vorherige schriftliche Zustimmung von HOPPE nicht gestattet.

These documents are property of HOPPE AG, D-35260 Stadtlendorf and are protected by both copyright and fair trade law. Any reproduction, reprint, copying, passing on to third parties and whichever use of these documents or parts thereof is prohibited, except with prior written consent of HOPPE.

Maßstab 1:2	Name Scholz	Datum 05.11.2014	Zeichnungsnummer c0023131z000	A400	HOPPE	Maßstab 1:2	Name Scholz	Datum 03.11.2014	Zeichnungsnummer QU=c0023129z007	A300	HOPPE
----------------	----------------	---------------------	----------------------------------	------	--------------	----------------	----------------	---------------------	-------------------------------------	------	--------------