

FS-E58/353KH/1400 PZ

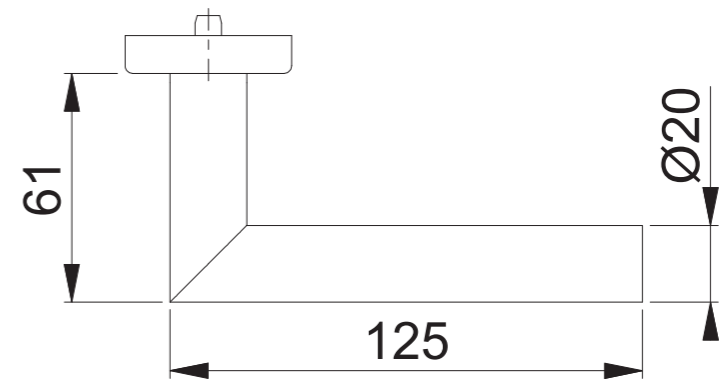

Maßstab 1:2	Name ASC5	Datum 16.06.2021	Zeichnungsnummer / Quelle c0023122z001 A4 01
----------------	--------------	---------------------	---

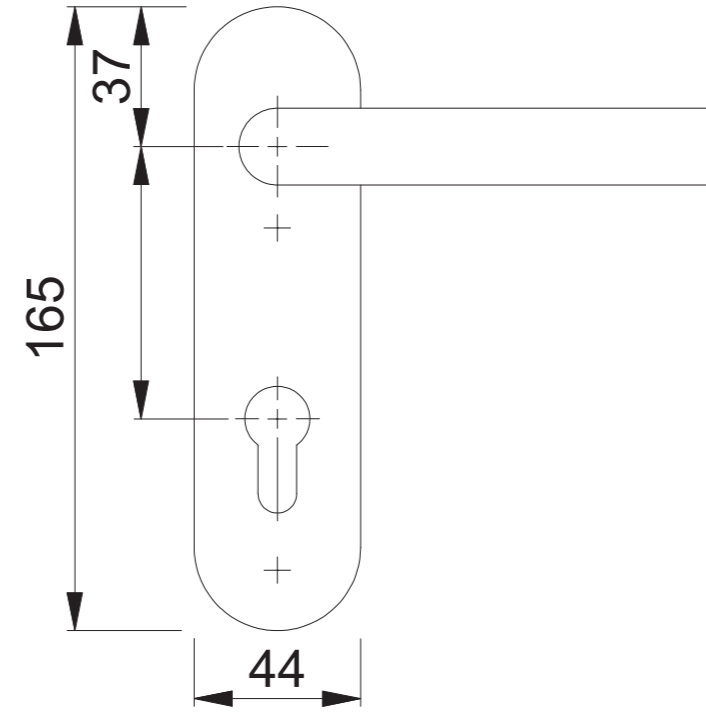
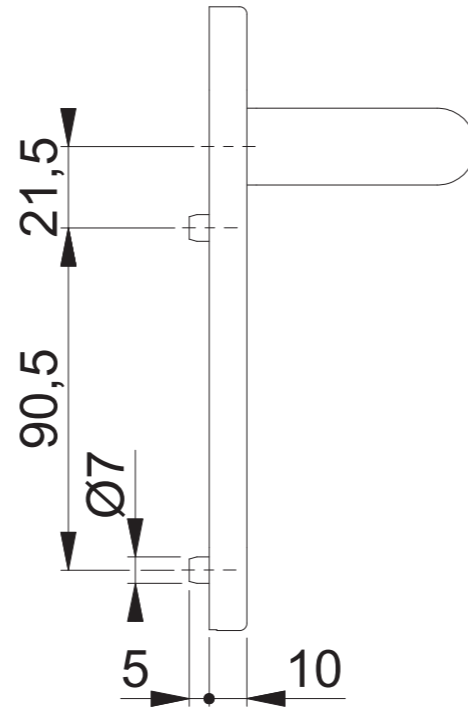
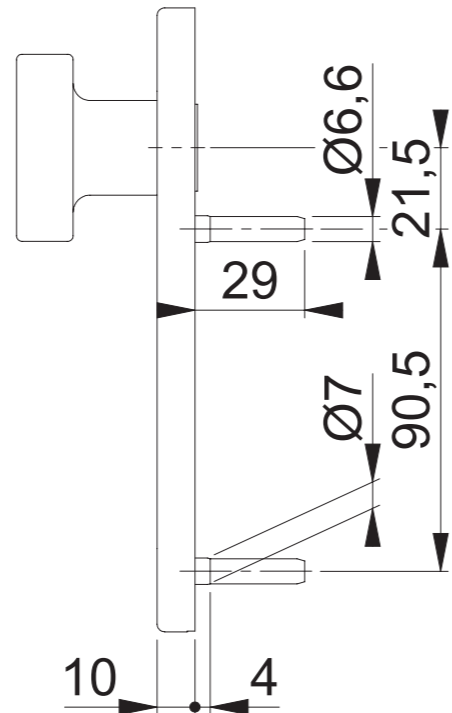
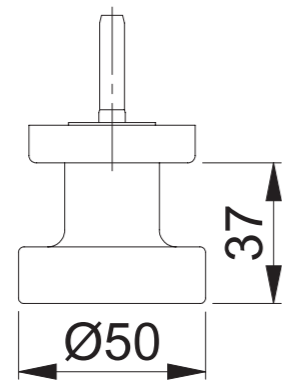
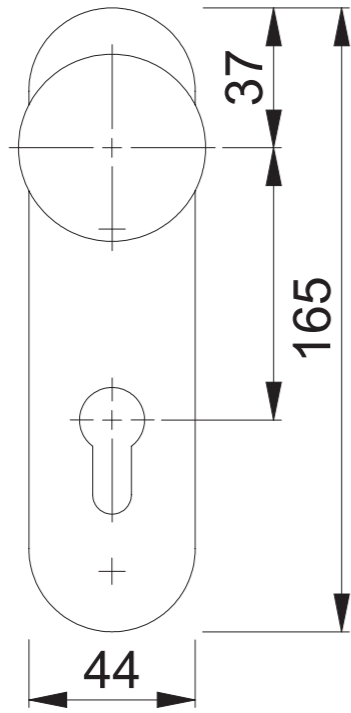

Maßstab 1:2	Name ASC5	Datum 29.10.2014	Zeichnungsnummer / Quelle c0023129z006 A3 00
----------------	--------------	---------------------	---

Artikel-Schriftfeld-CAD
FS-E1400(F)/353KH/353KH/1400(F) PZ

