

# FS-E58/353KH/1141 PZ

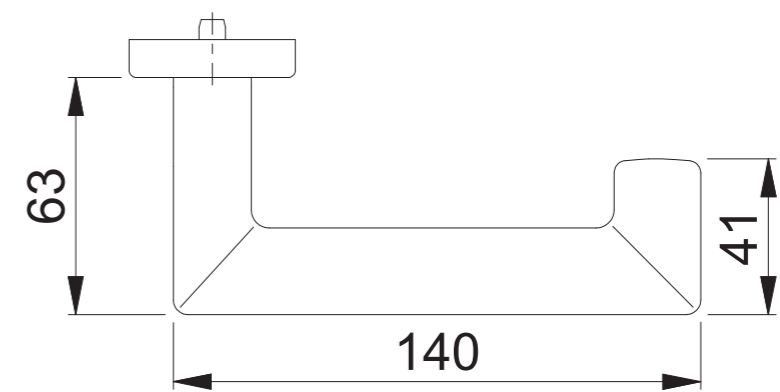

Maßstab 1:2	Name ASC5	Datum 16.06.2021	Zeichnungsnummer / Quelle c0023122z001	A4 01
----------------	--------------	---------------------	---	-------

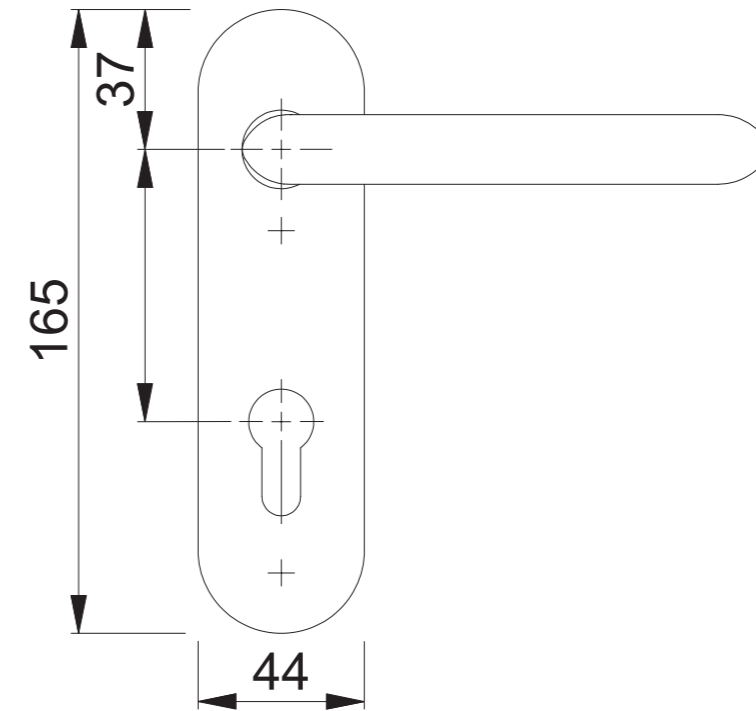
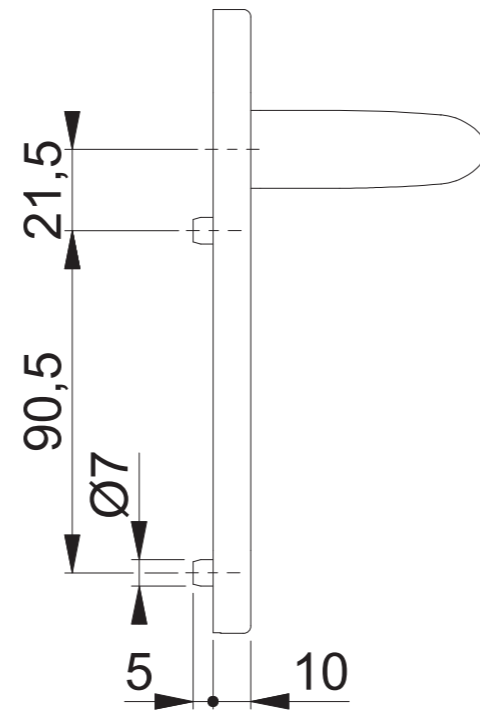
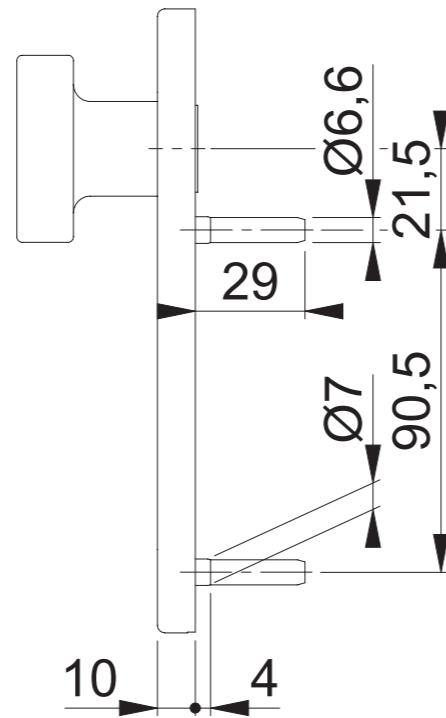
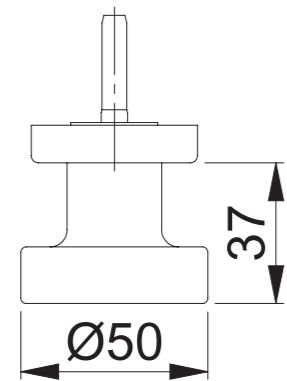
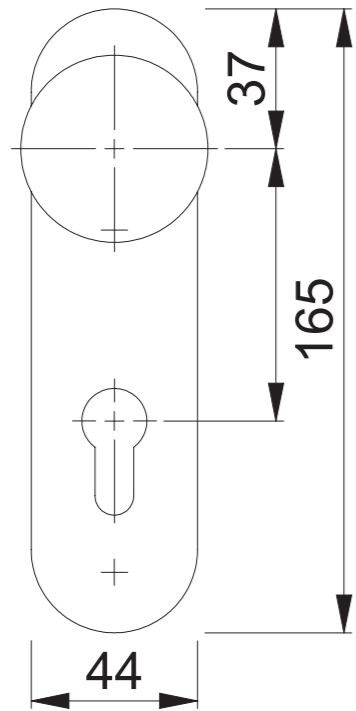

Maßstab 1:2	Name ASC5	Datum 29.10.2014	Zeichnungsnummer / Quelle c0023129z004	A3 00
----------------	--------------	---------------------	---	-------

Artikel-Schriftfeld-CAD  
FS-E1141(F)/353KH/353KH/1141(F) PZ

