

FS-E1644F/2222ZA/2210 PZ ES1/SK2

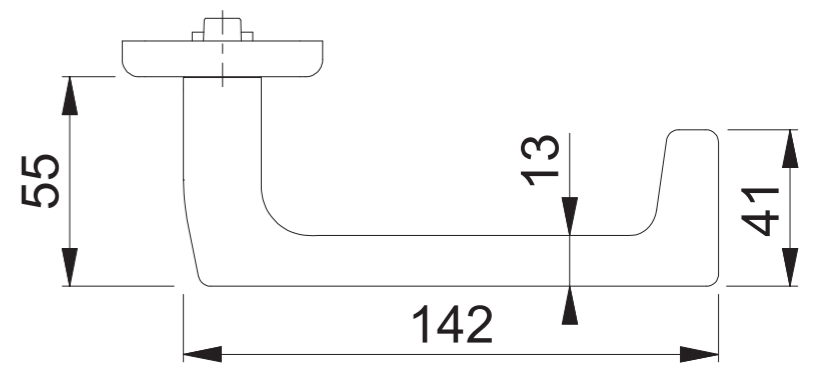
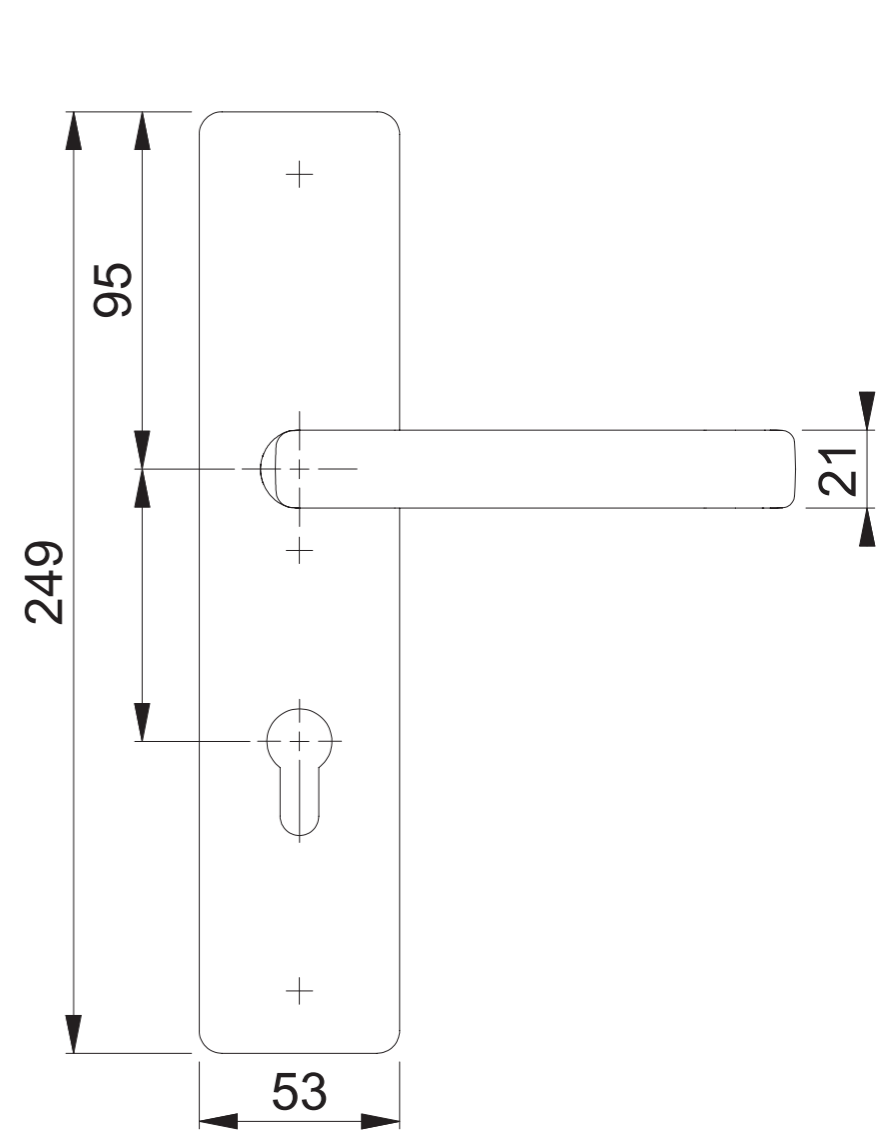
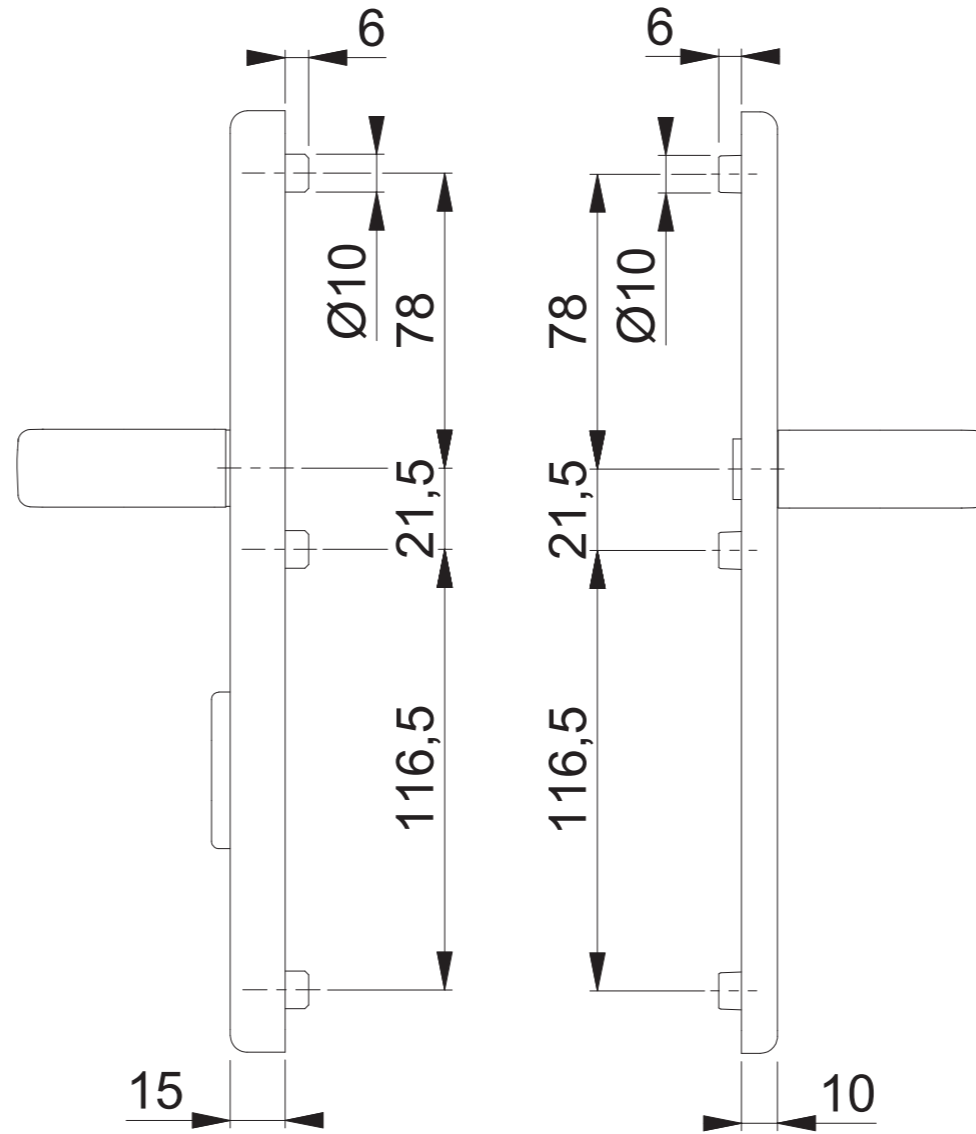
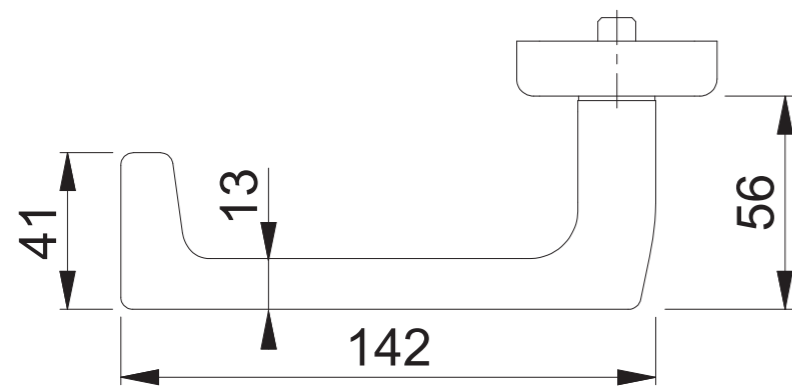
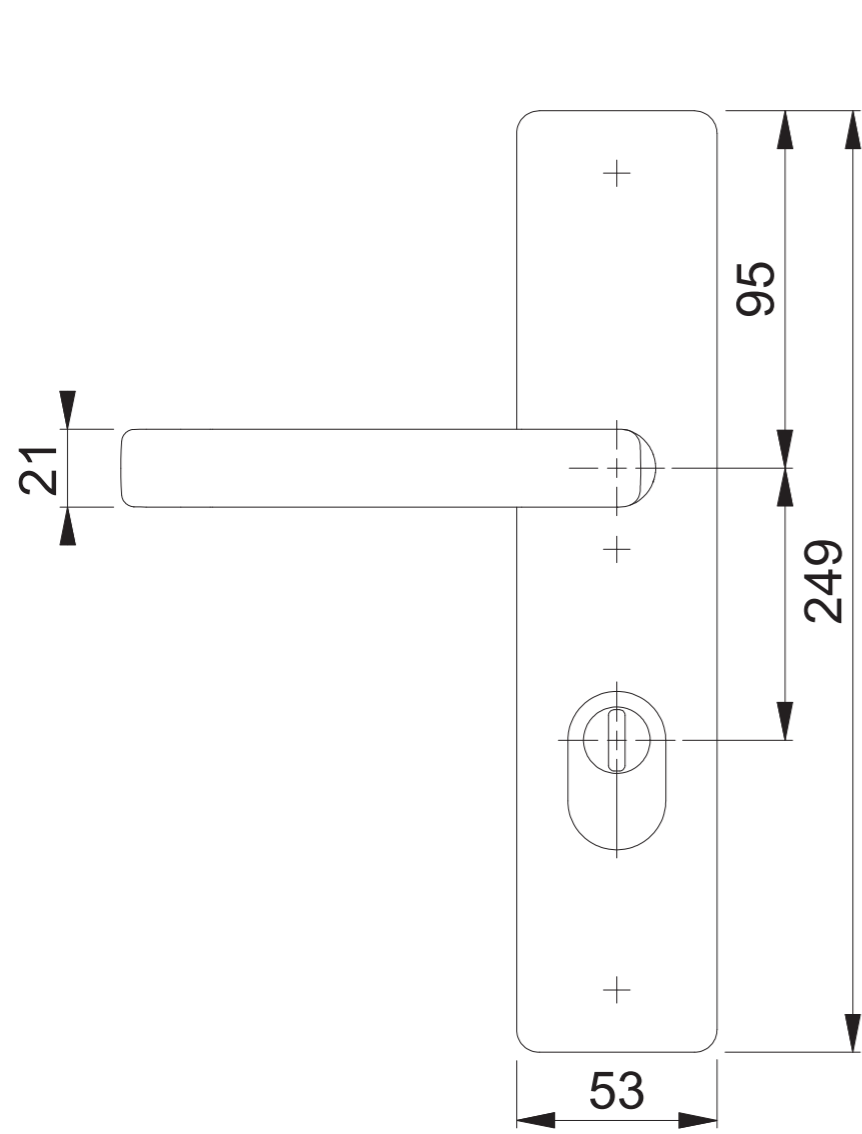

Maßstab 1:2	Name Scholz	Datum 23.05.2014	Zeichnungsnummer c00203096z001	A3 00	HOPPE	Maßstab 1:2	Name Schultheis	Datum 12.11.2013	Zeichnungsnummer c0022892z001	A4 00	HOPPE
----------------	----------------	---------------------	-----------------------------------	-------	--------------	----------------	--------------------	---------------------	----------------------------------	-------	--------------