

FS-E1430/353KH PZ (E1430F)

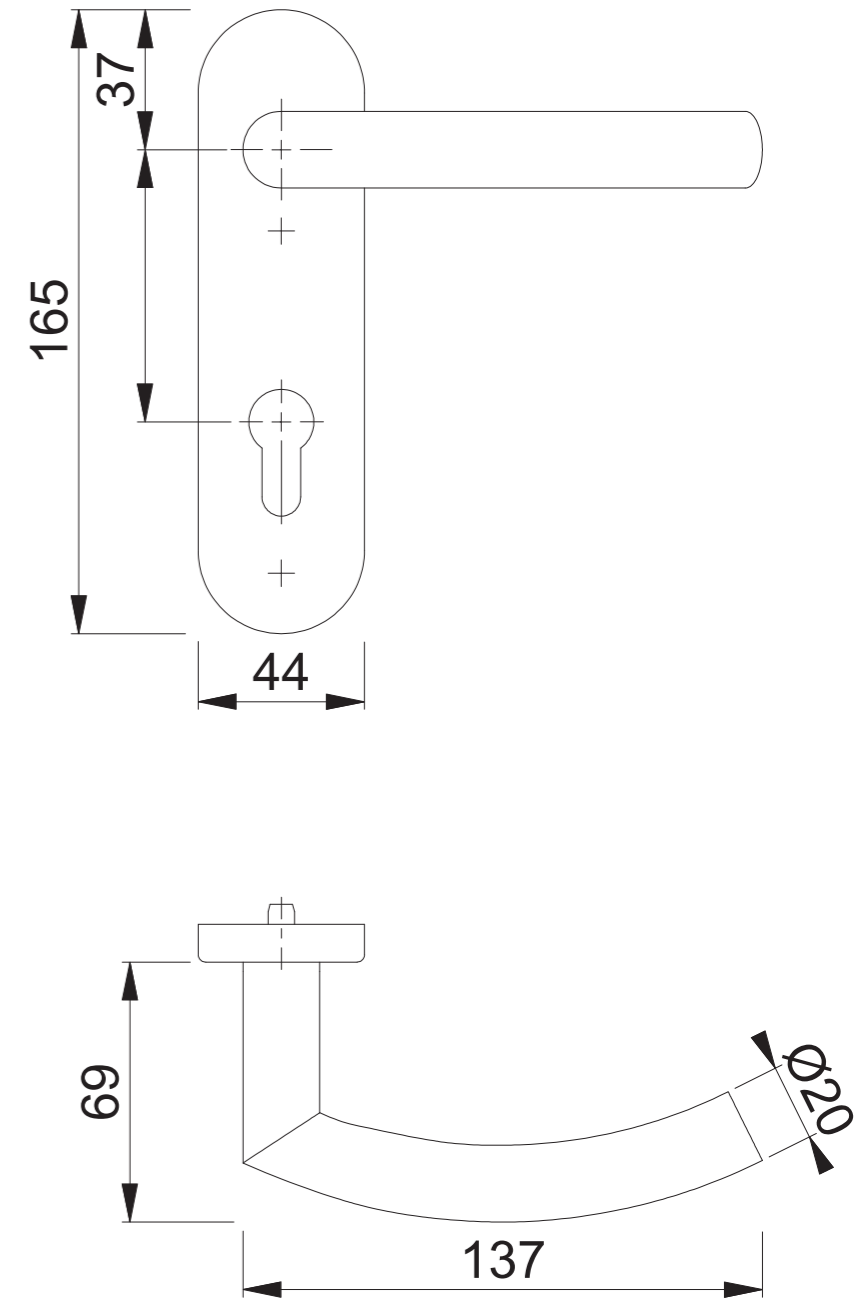
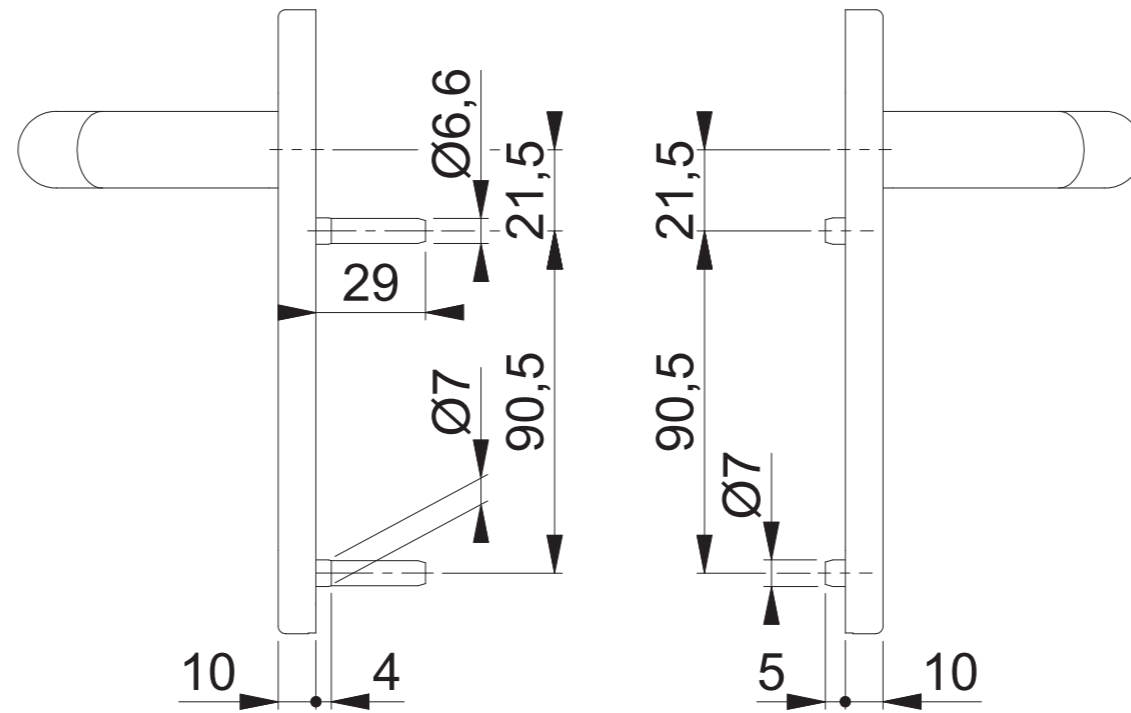
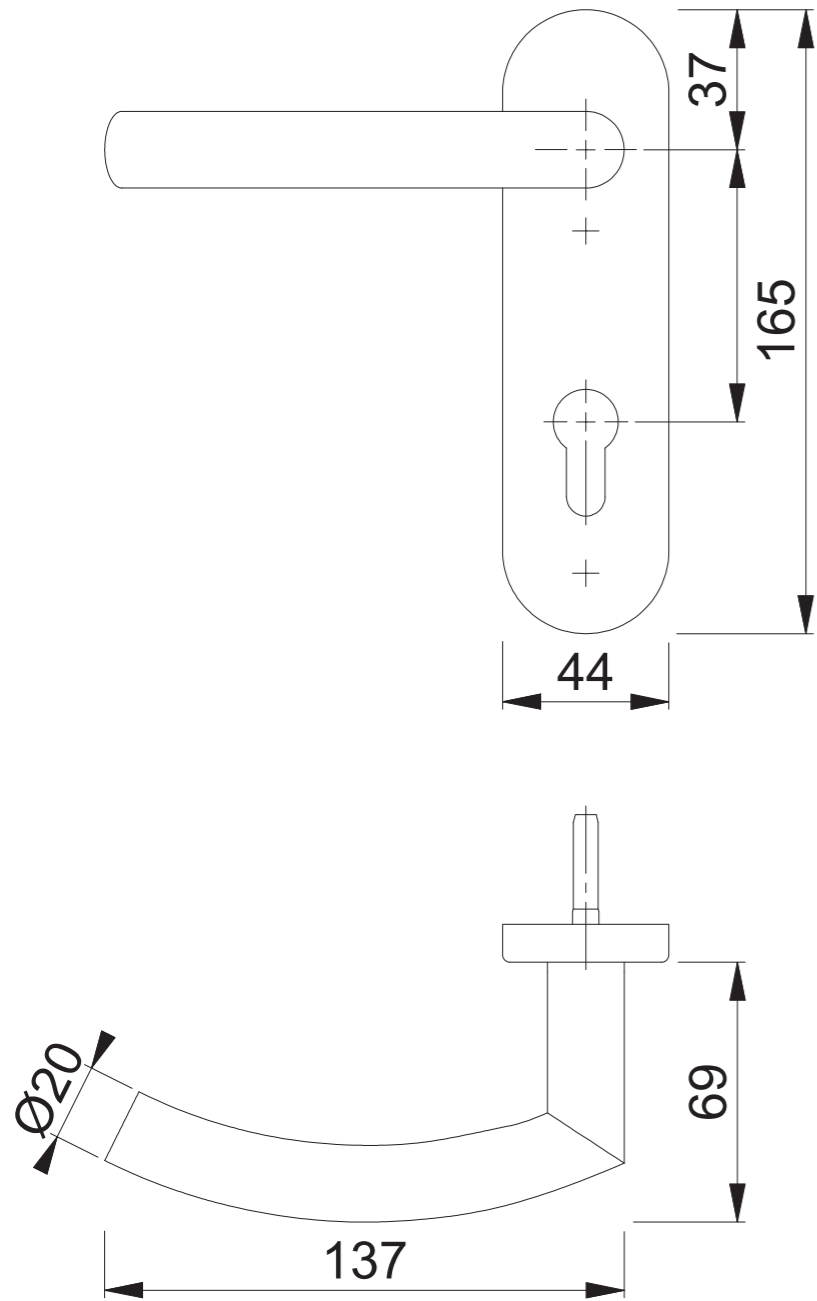

Maßstab 1:2	Name Scholz	Datum 29.10.2014	Zeichnungsnummer c0023128z008	A300	HOPPE
----------------	----------------	---------------------	----------------------------------	------	--------------