

FS-E1401/353H PZ

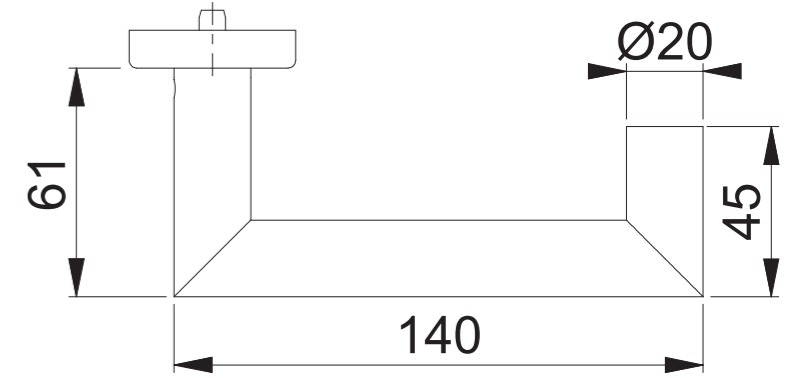

Maßstab	Name	Datum	Zeichnungsnummer	
1:2	Bauer	10.05.2016	c0023245z006	A300

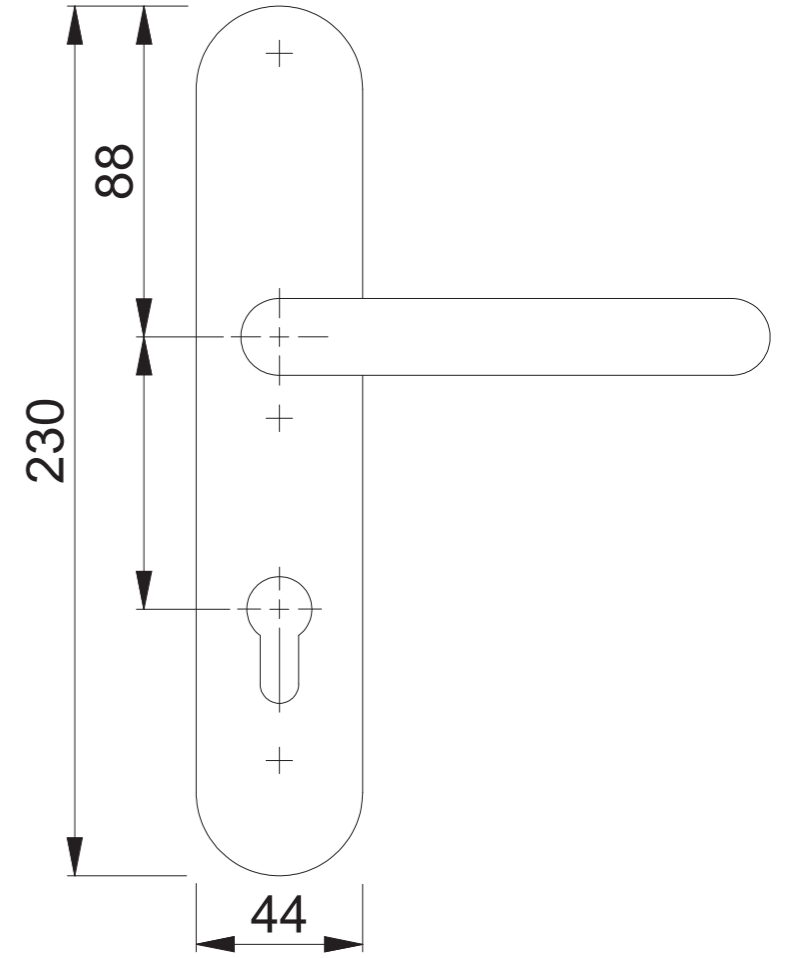
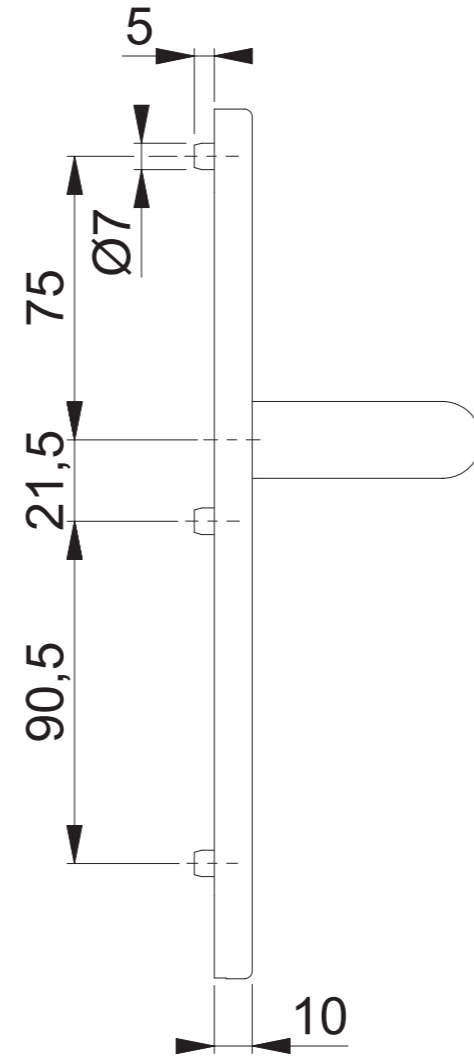
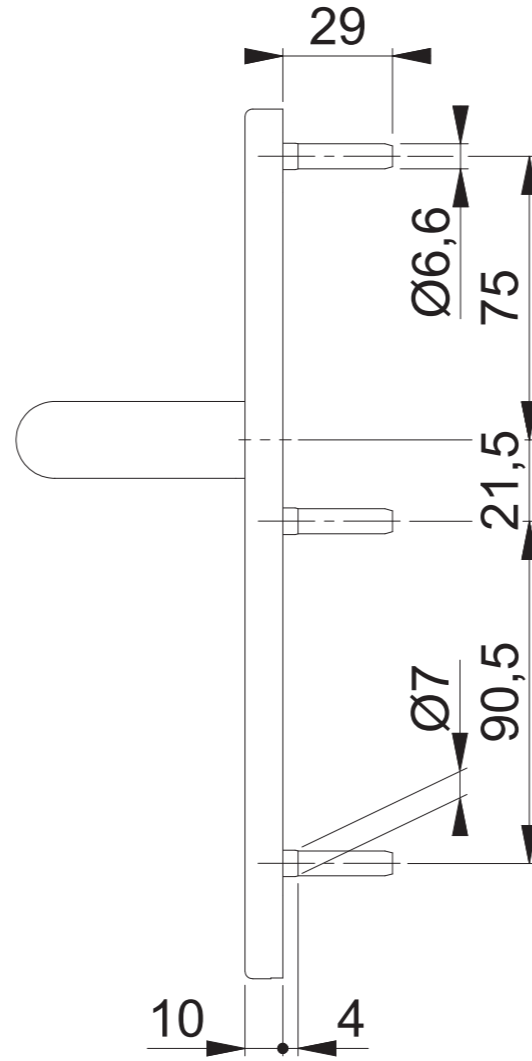
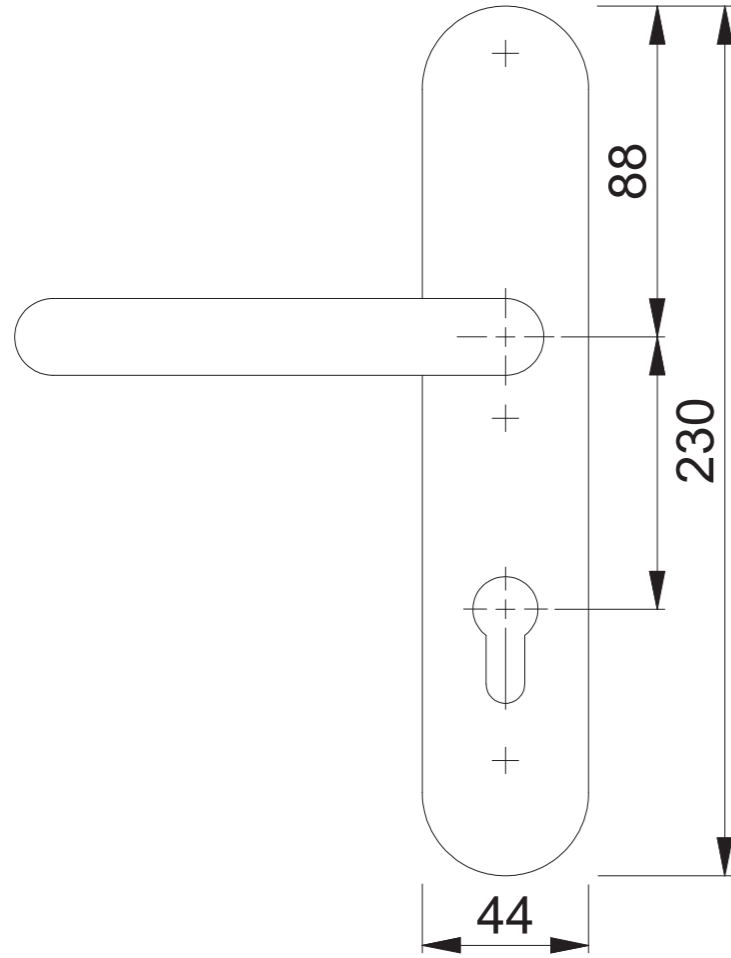
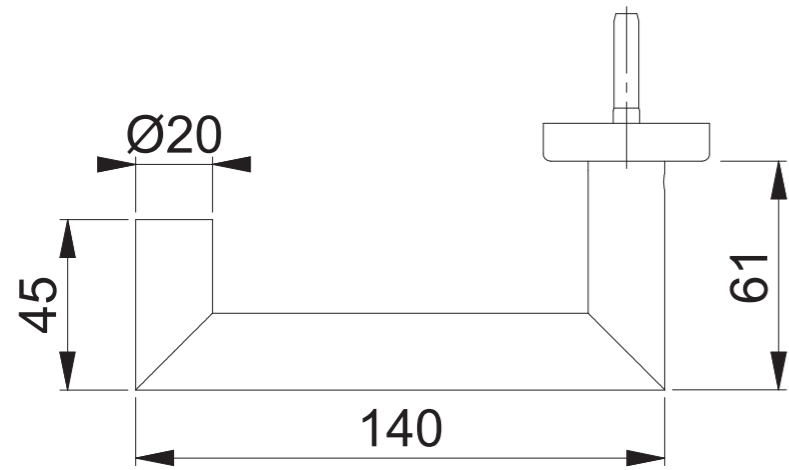