

FS-E1400/353H PZ

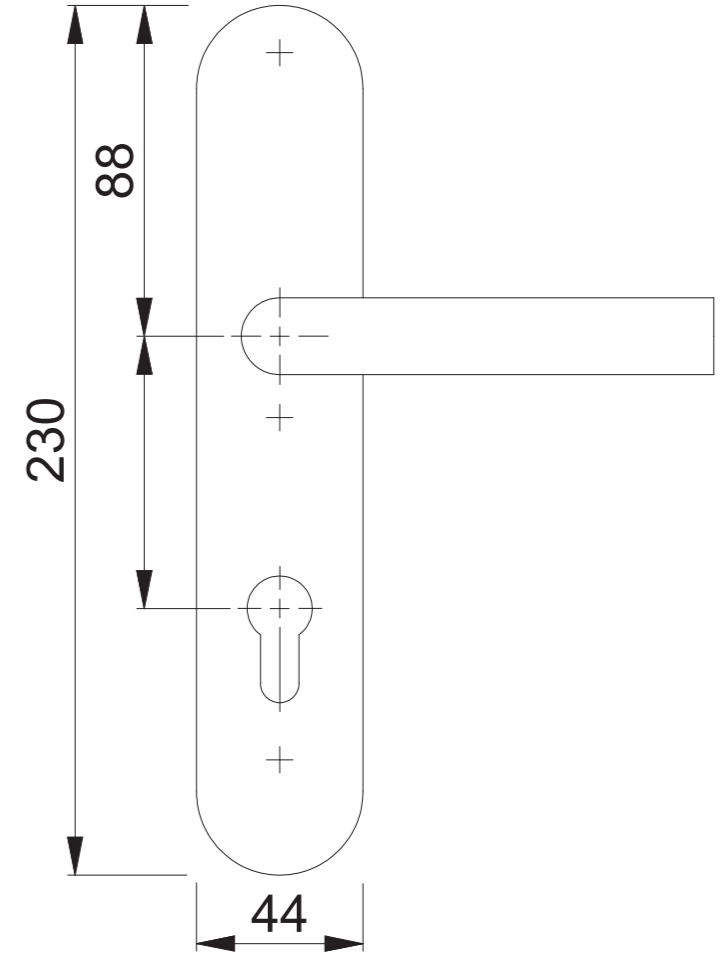

Maßstab	Name	Datum	Zeichnungsnummer	
1:2	Bauer	10.05.2016	c0023245z005	A300

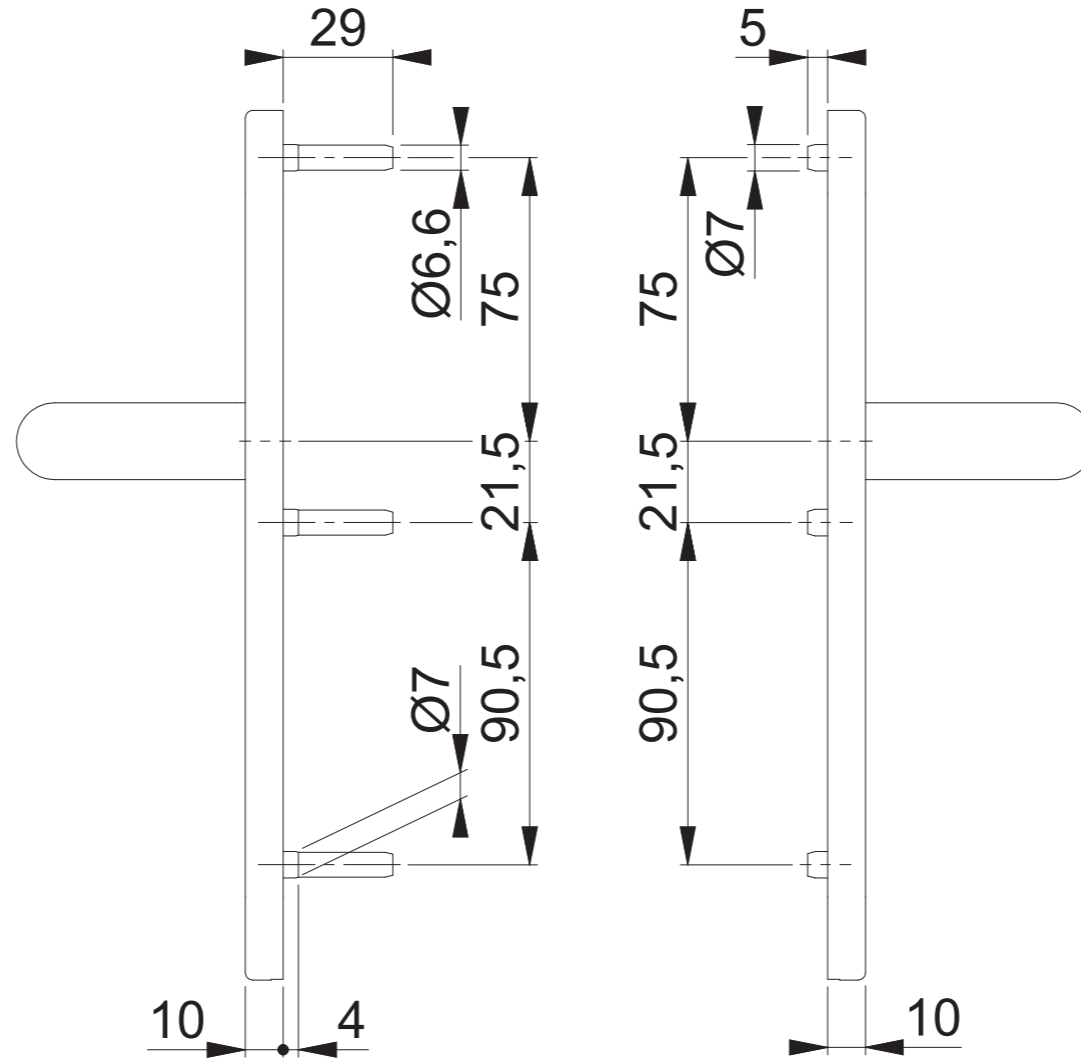
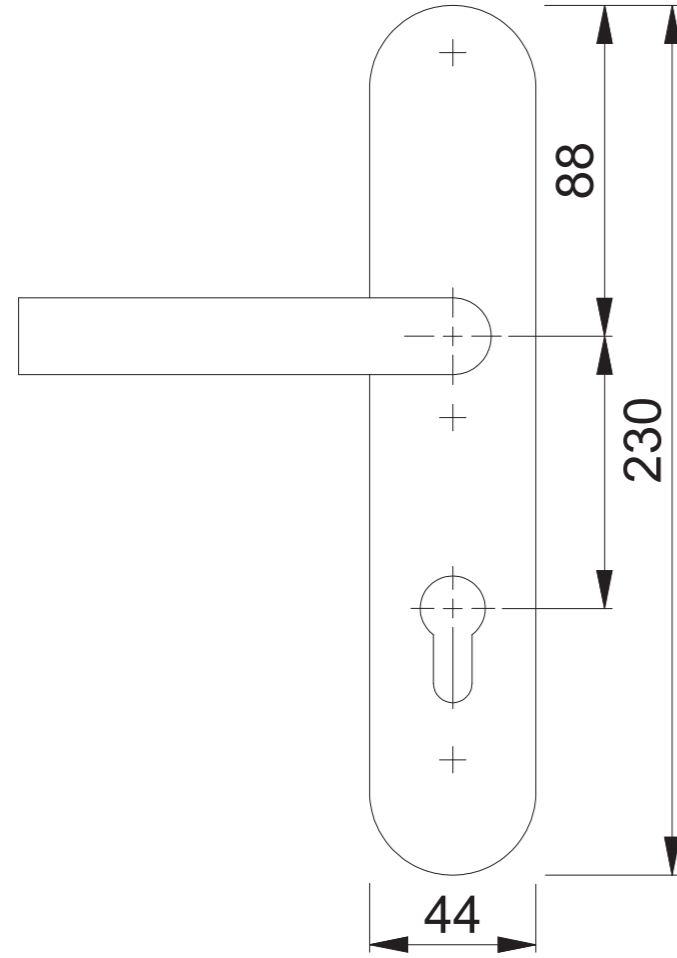
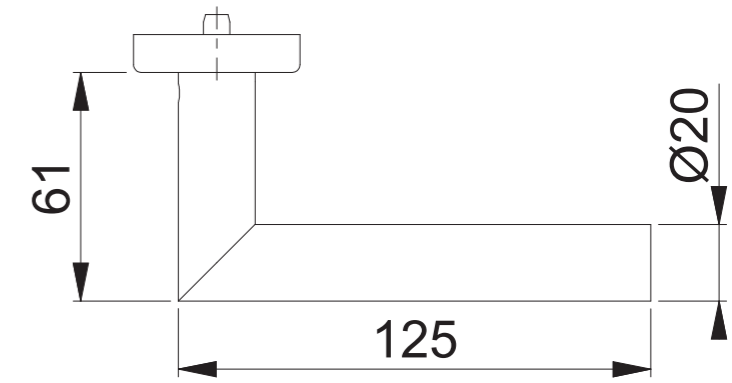
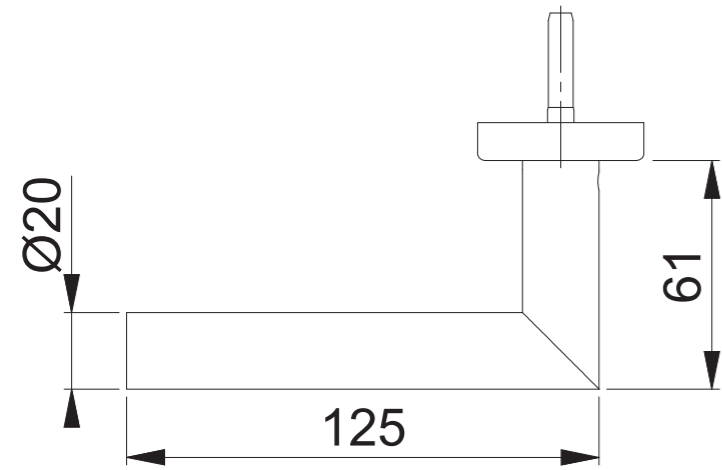