

FS-E1301/353KH PZ (E1301F)

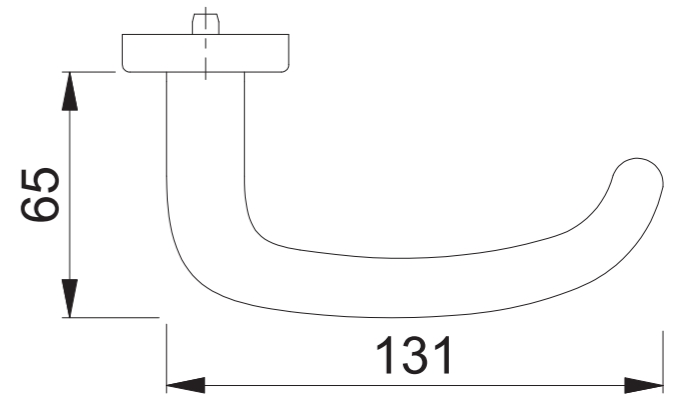
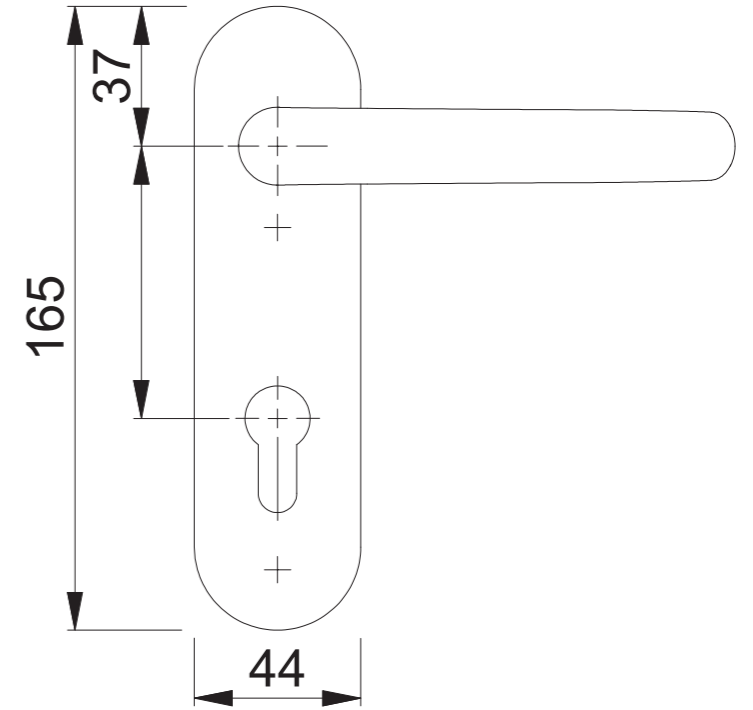
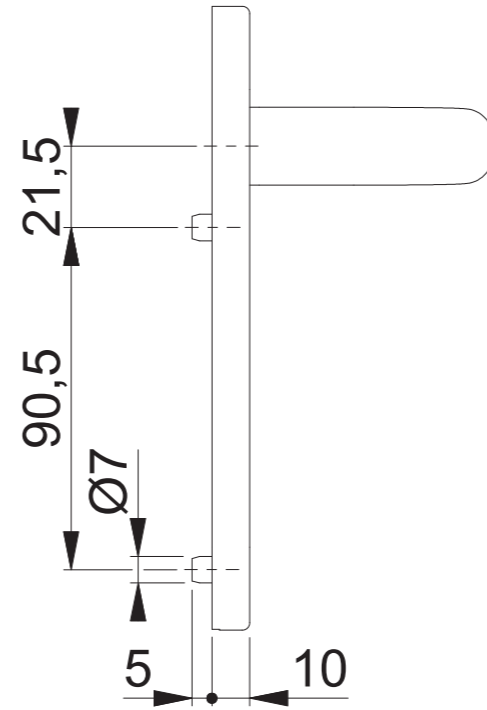
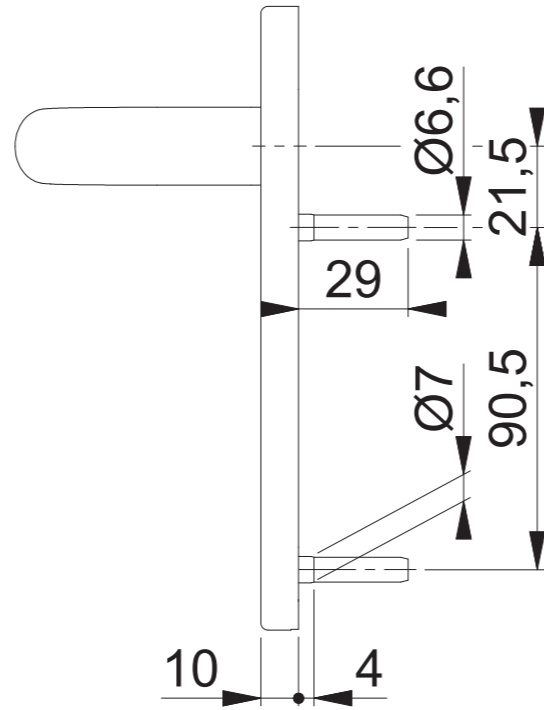
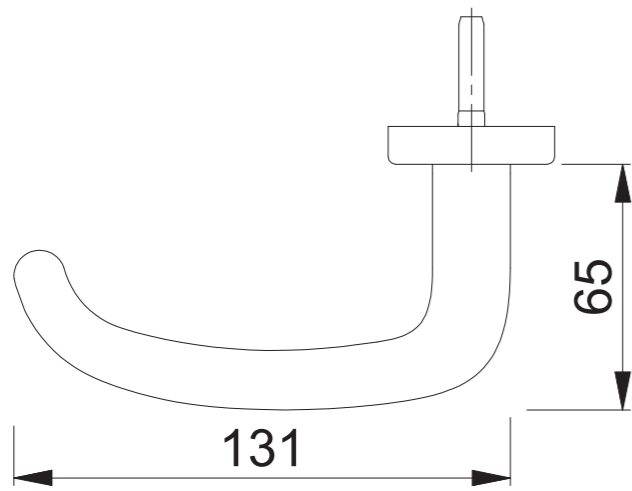
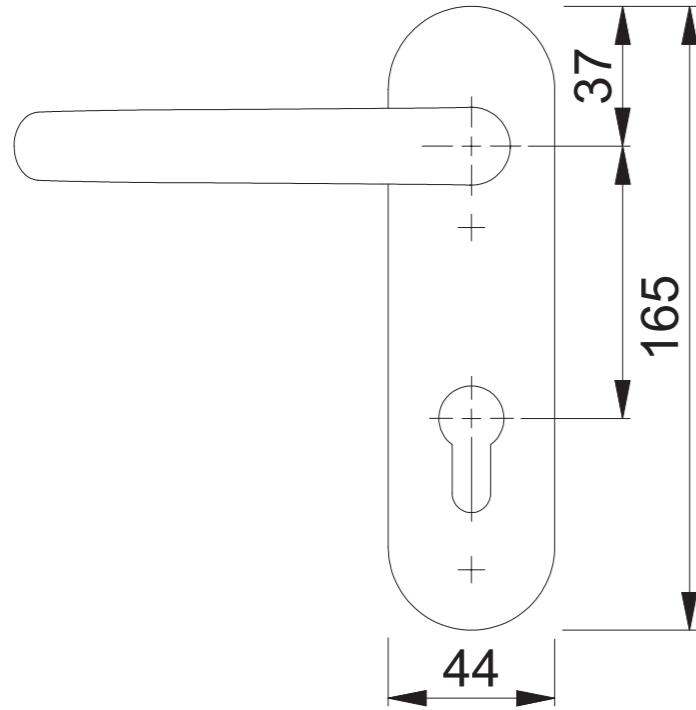

Maßstab 1:2	Name Scholz	Datum 29.10.2014	Zeichnungsnummer c0023128z005	A300	HOPPE
----------------	----------------	---------------------	----------------------------------	------	--------------