

FS-E1141/353KH PZ (E1141F)

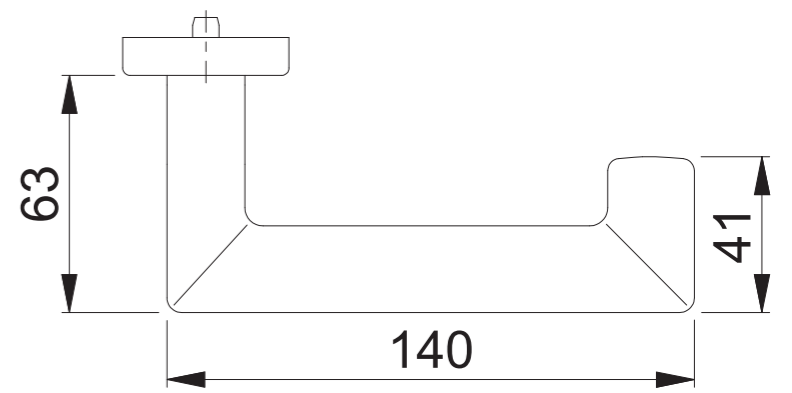
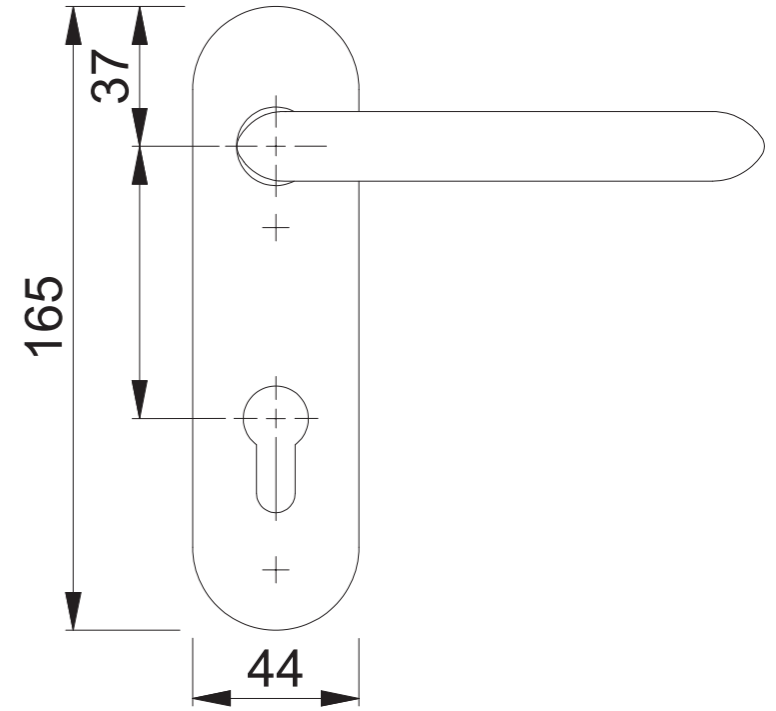
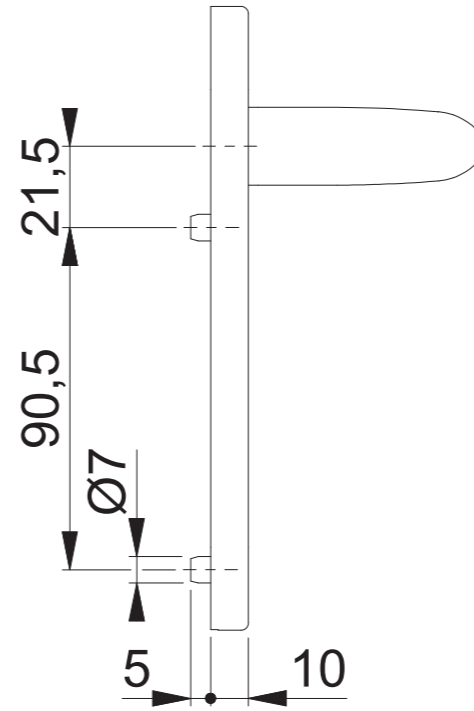
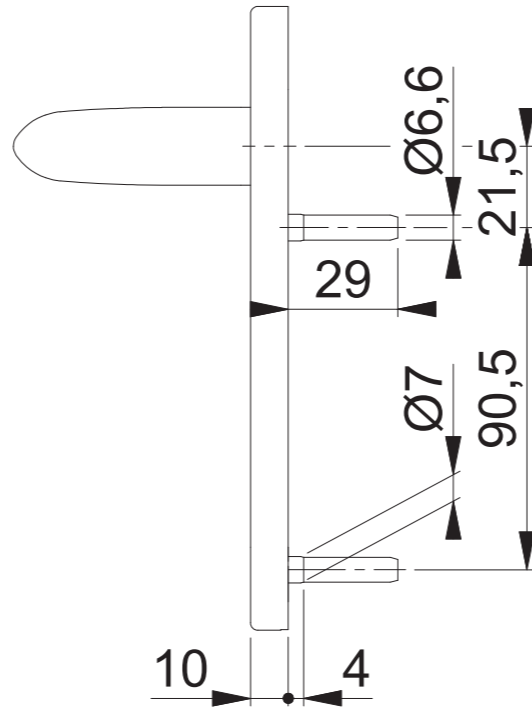
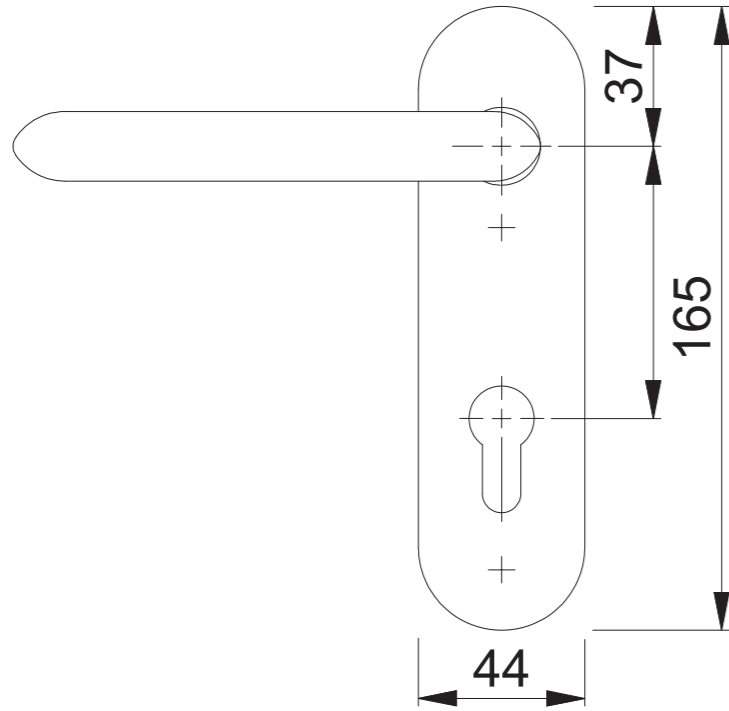
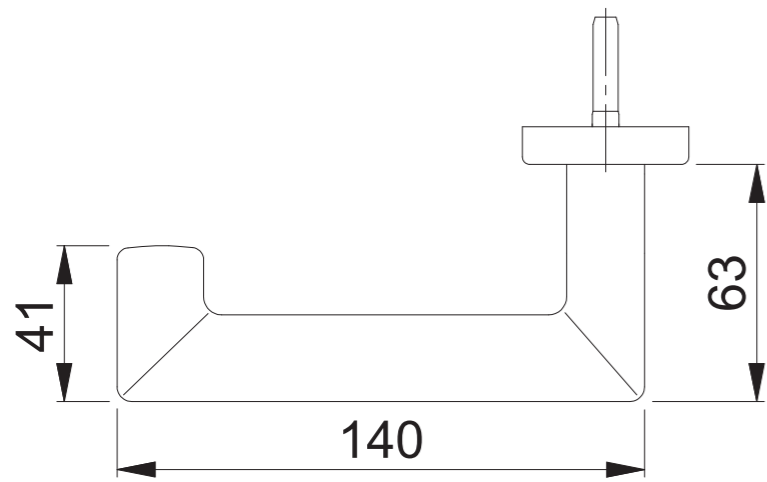

Maßstab 1:2	Name Scholz	Datum 29.10.2014	Zeichnungsnummer c0023129z004	A300	HOPPE
----------------	----------------	---------------------	----------------------------------	------	--------------