

FS-E1140/353KH blind/PZ

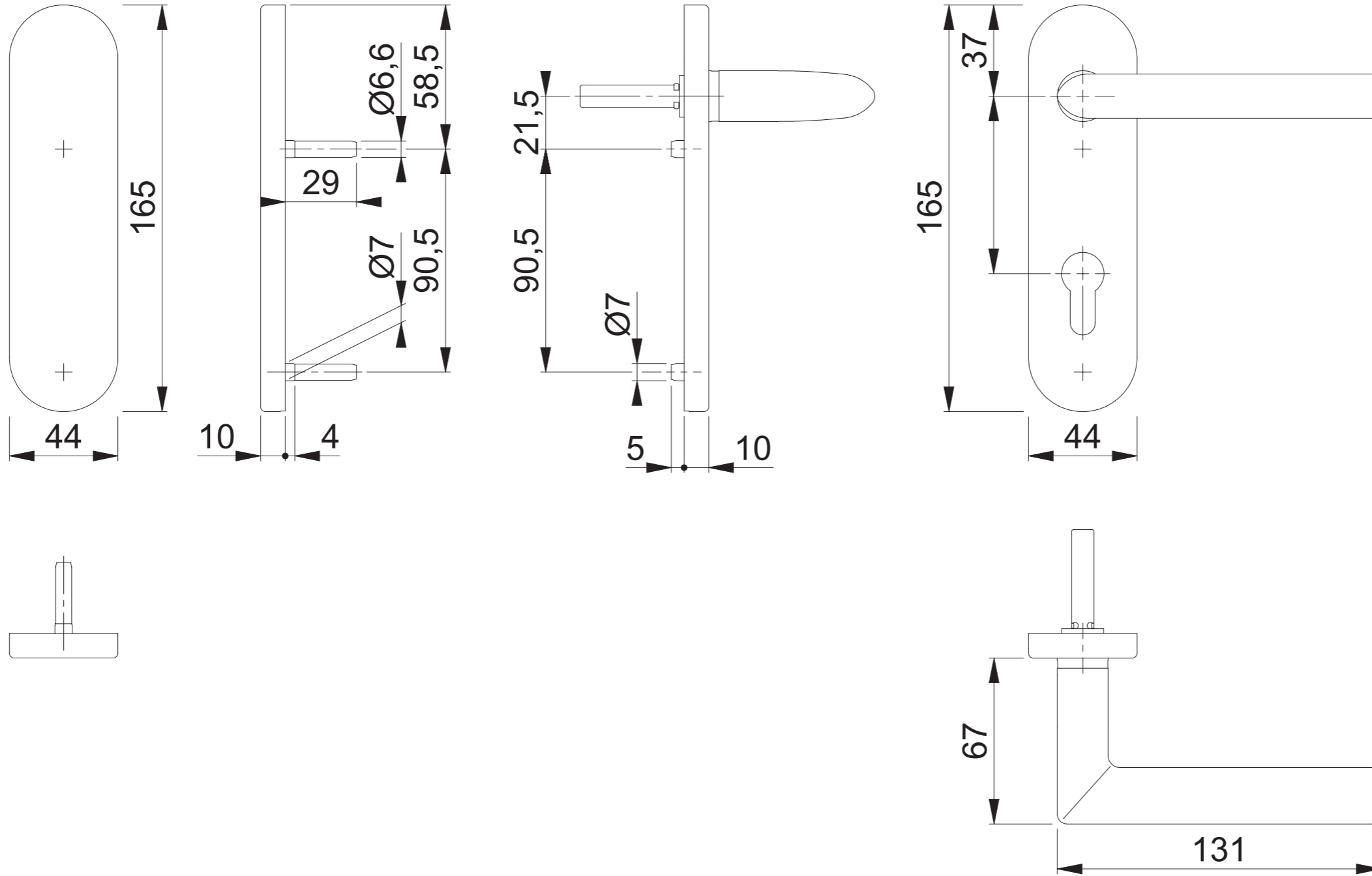

Maßstab 1:2	Name ASC5	Datum 12.02.2018	Zeichnungsnummer / Quelle c0023298z002	A3 00
Artikel-Schriftfeld-CAD FS-SF-E353KH/353KH/1140F; blind/PZ; SUP52-4-BG39				