

FS-1644/202KH PZ

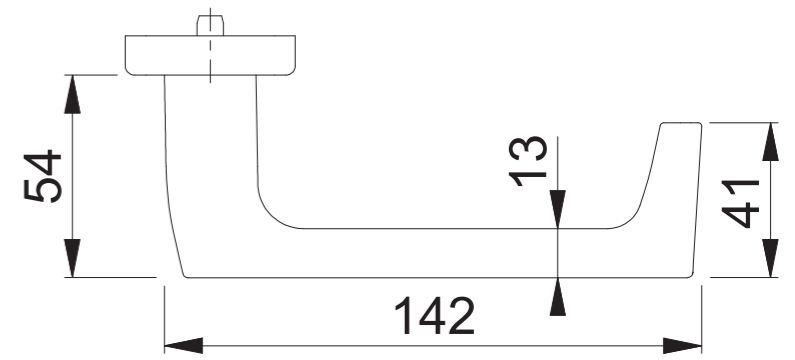
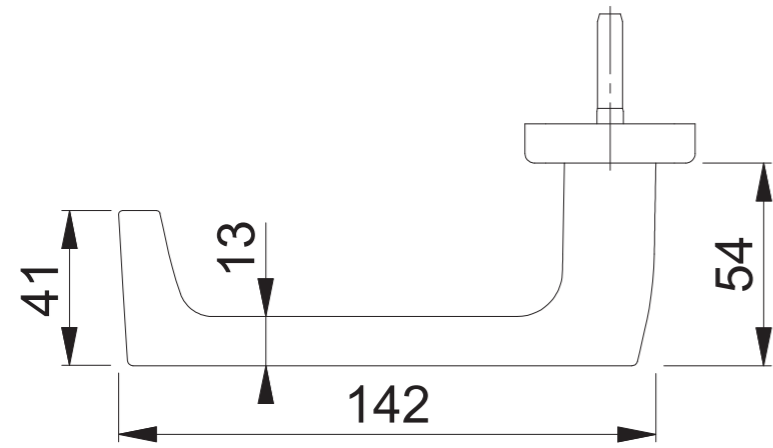
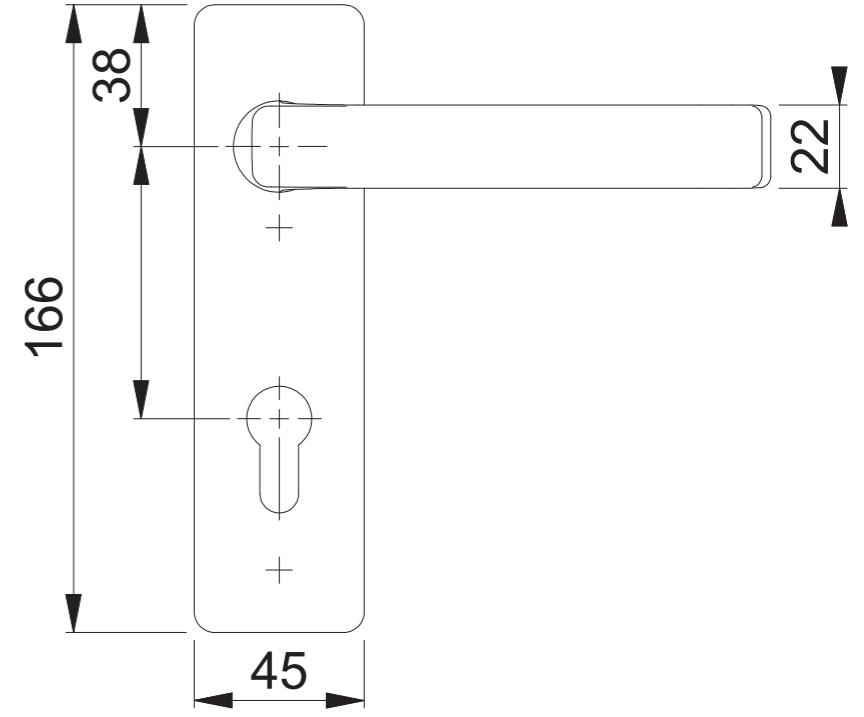
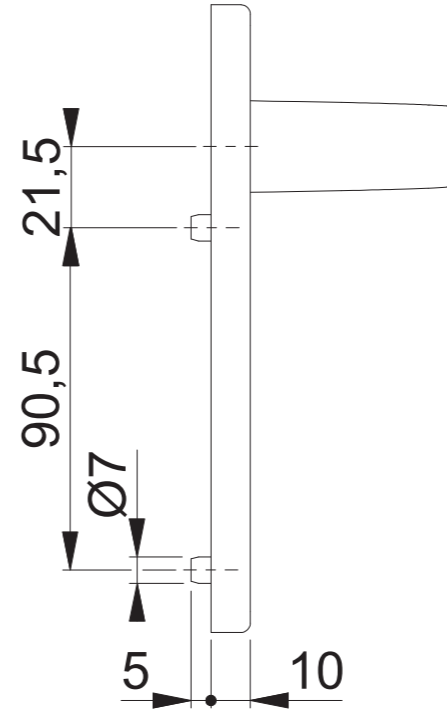
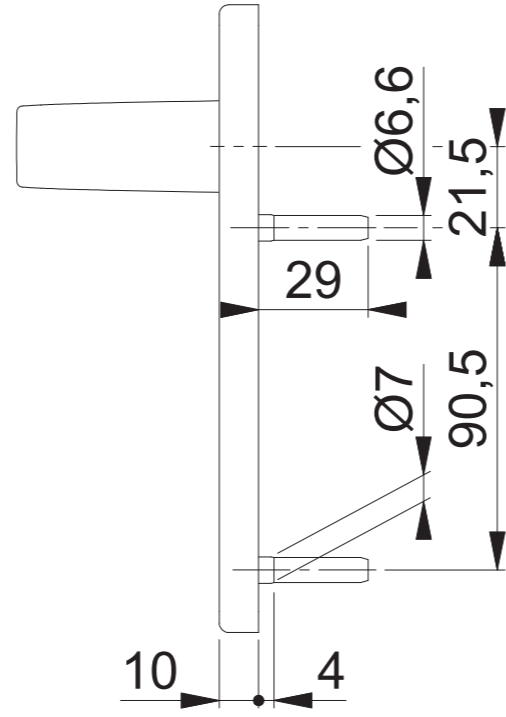
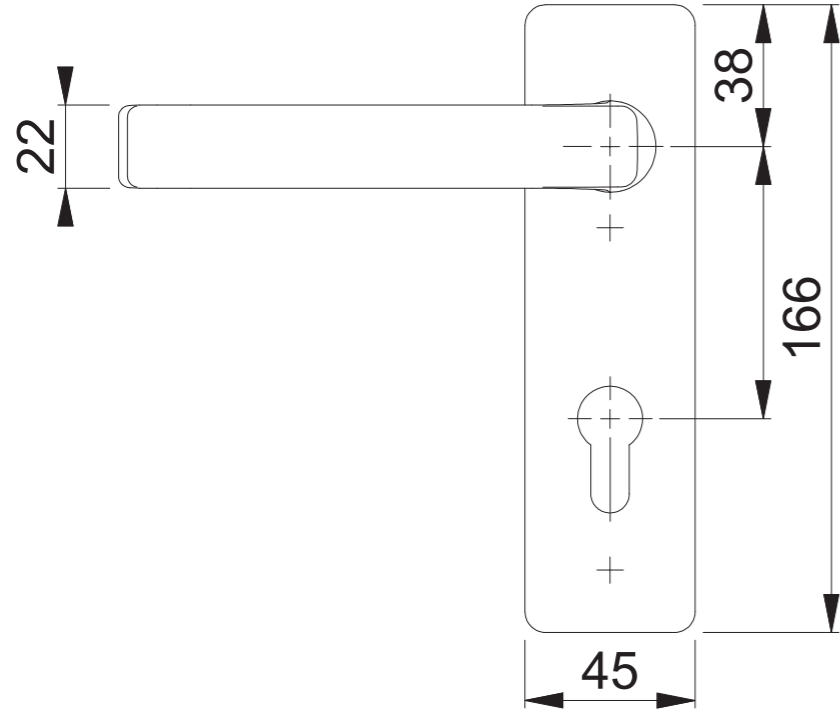

Maßstab 1:2	Name Scholz	Datum 04.12.2014	Zeichnungsnummer c0023151z001	A300	HOPPE
----------------	----------------	---------------------	----------------------------------	------	--------------