

E5092 (600/400)

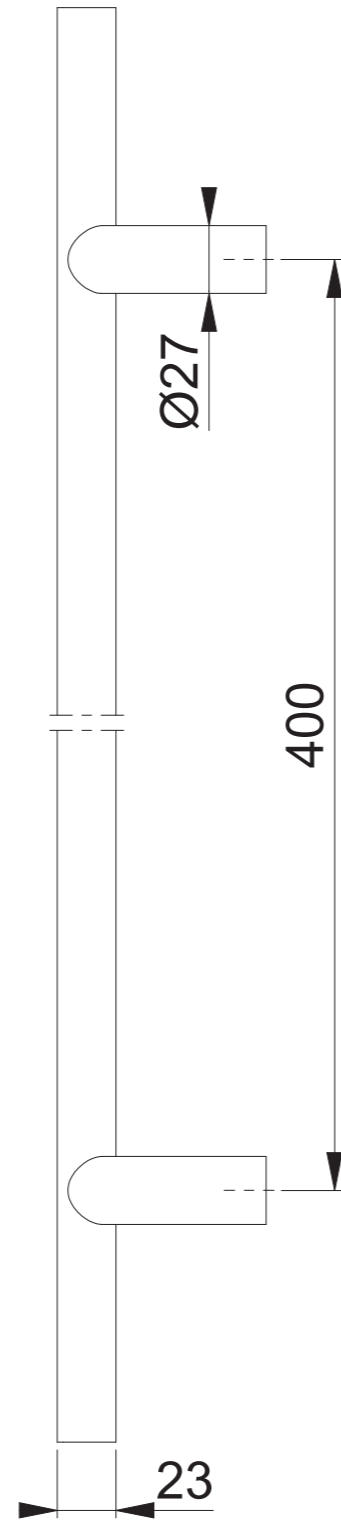
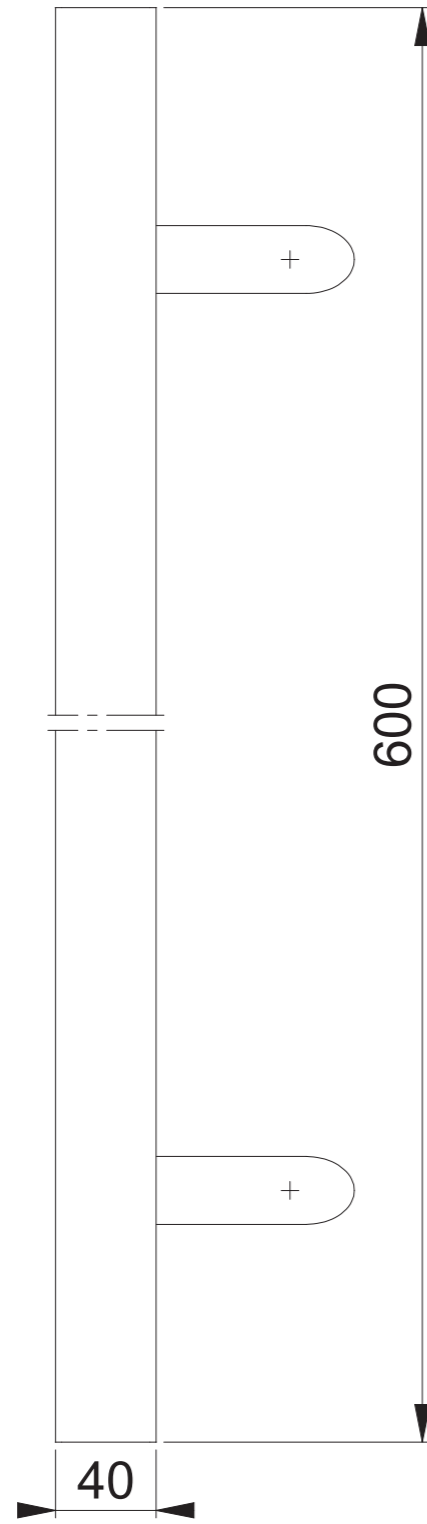
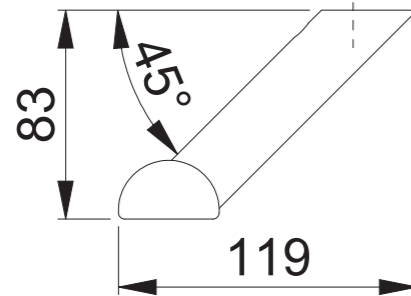

Maßstab	Name	Datum	Zeichnungsnummer / Quelle	
1:3	ASC5	06.11.2018	c1382130g001	A3 00

Artikel-Schriftfeld-CAD
E5092 Länge 800; schräge Stützen - Abstand 560