

E3331 UG SKG3

Bearbeitet / Datum

HHH/05.08.22

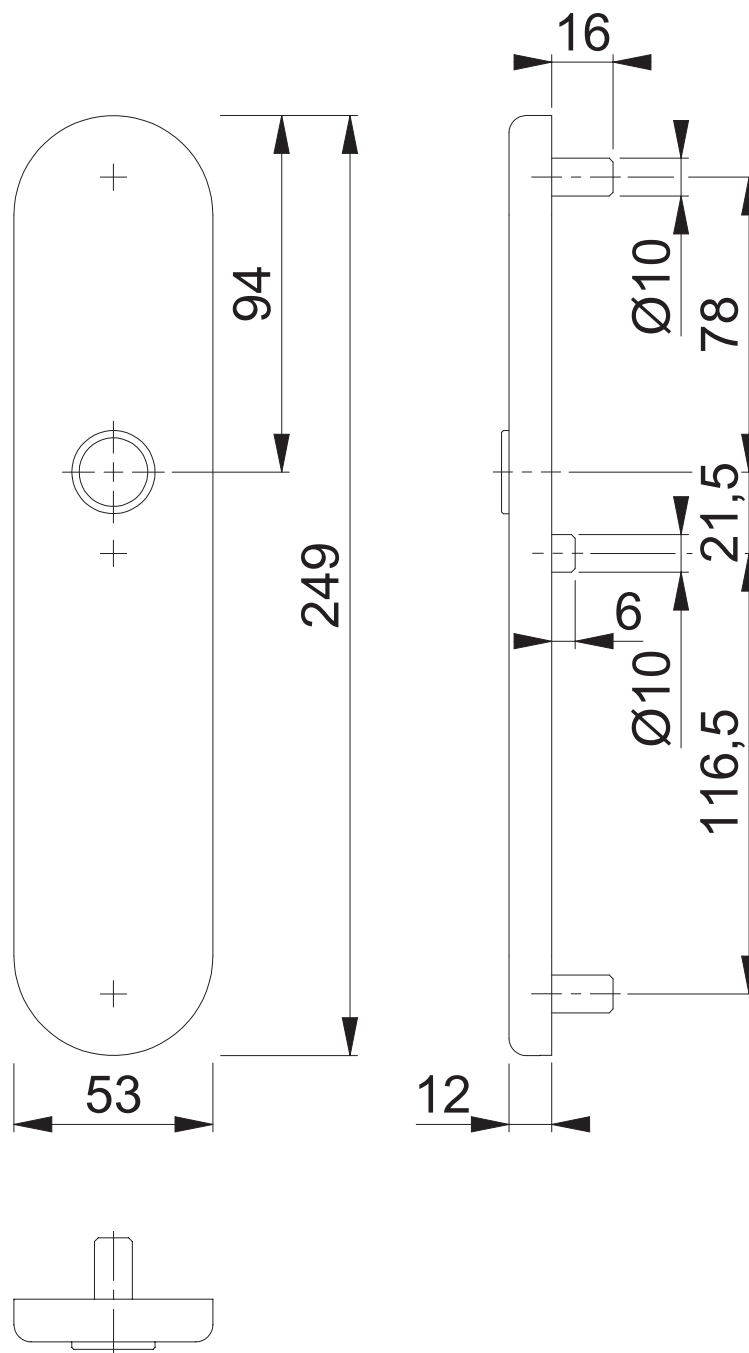

Maßstab
1:2

Name
ASC5

Datum
12.04.2022

Zeichnungsnummer / Quelle
c0023397z000

A4 00

Artikel-Schriftfeld-CAD

E3331/3310 ES1; PZ72; 3N-lang

HOPPE 