

E138Z/42H (RFL16-BG5)

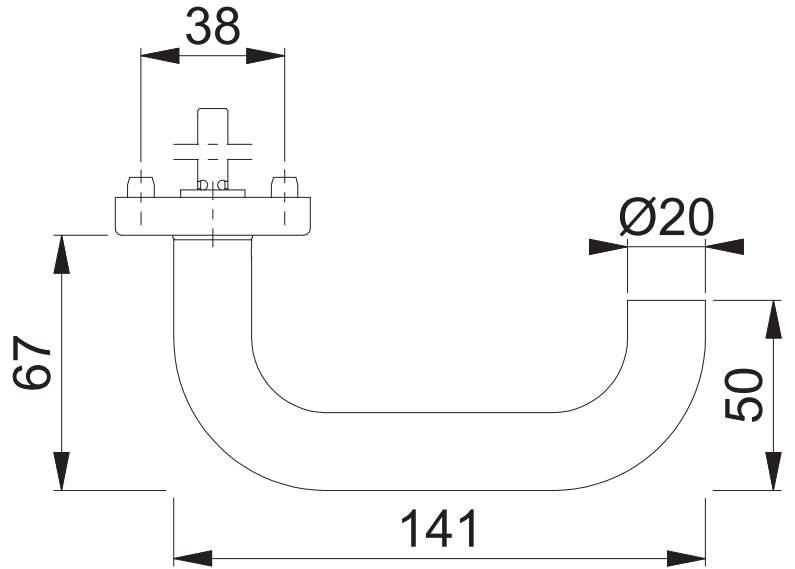
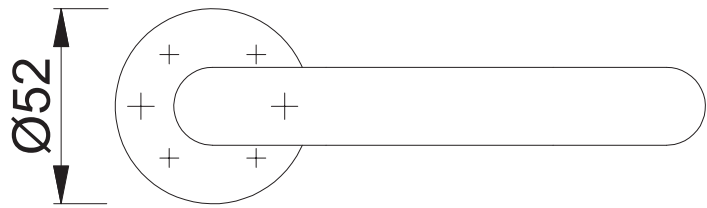
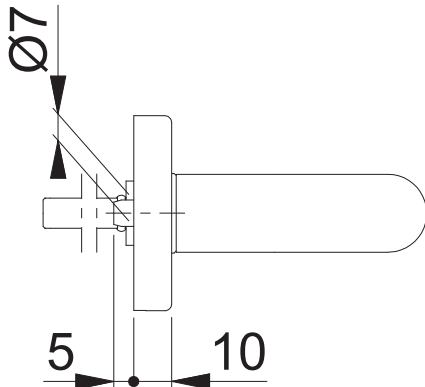

Maßstab	Name	Datum	Zeichnungsnummer		
1:2	Scholz	07.04.2016	c0023240z000	A4 00	HOPPE 