

Copyright © HOPPE AG

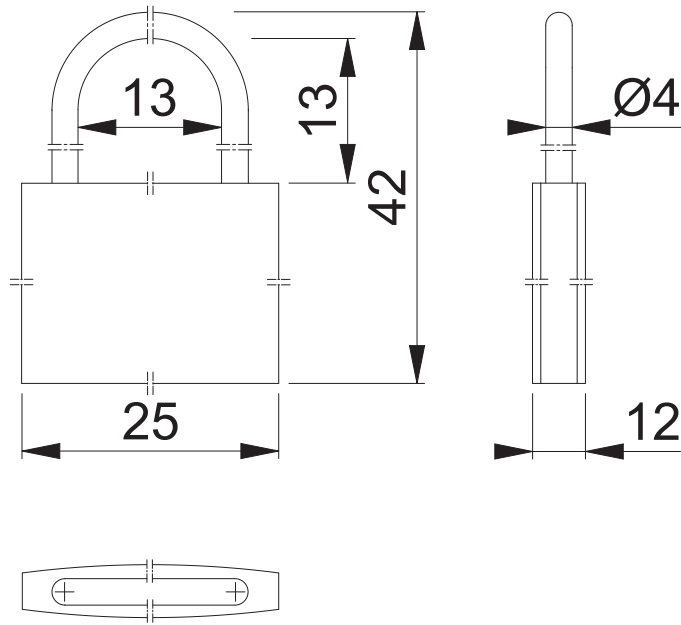

These documents are property of HOPPE (UK) LTD, Wolverhampton and are protected by both copyright and fair trade law. Any reproduction, reprint, copying, passing on to third parties and whichever use of these documents or parts thereof is prohibited, except with prior written consent of HOPPE.

Scale	Name	Date	Drawing No. / Source
-	HHA	26.02.26	-

Article-Titleblock CAD-database
AB-65/25

ARRONE