

199/273P SK/OL (KSK27/OL92)

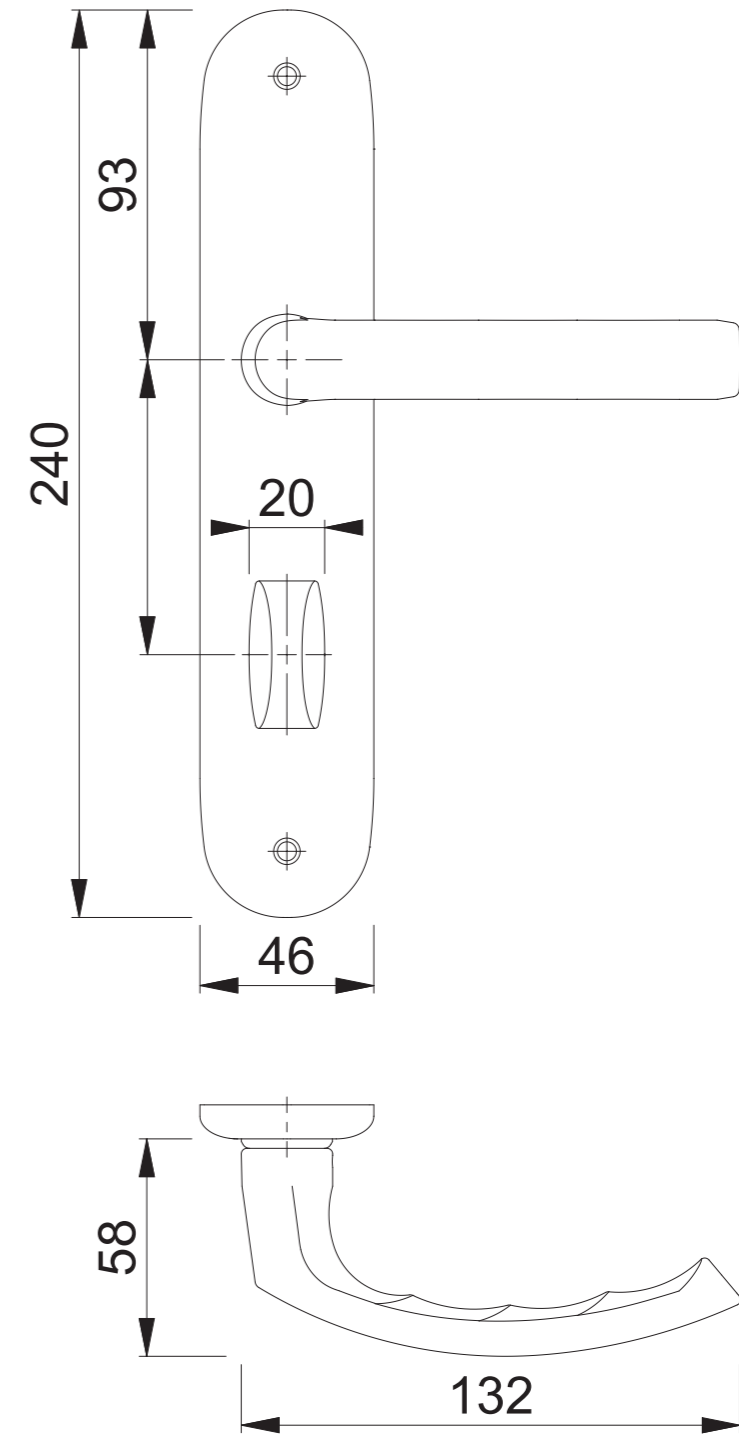
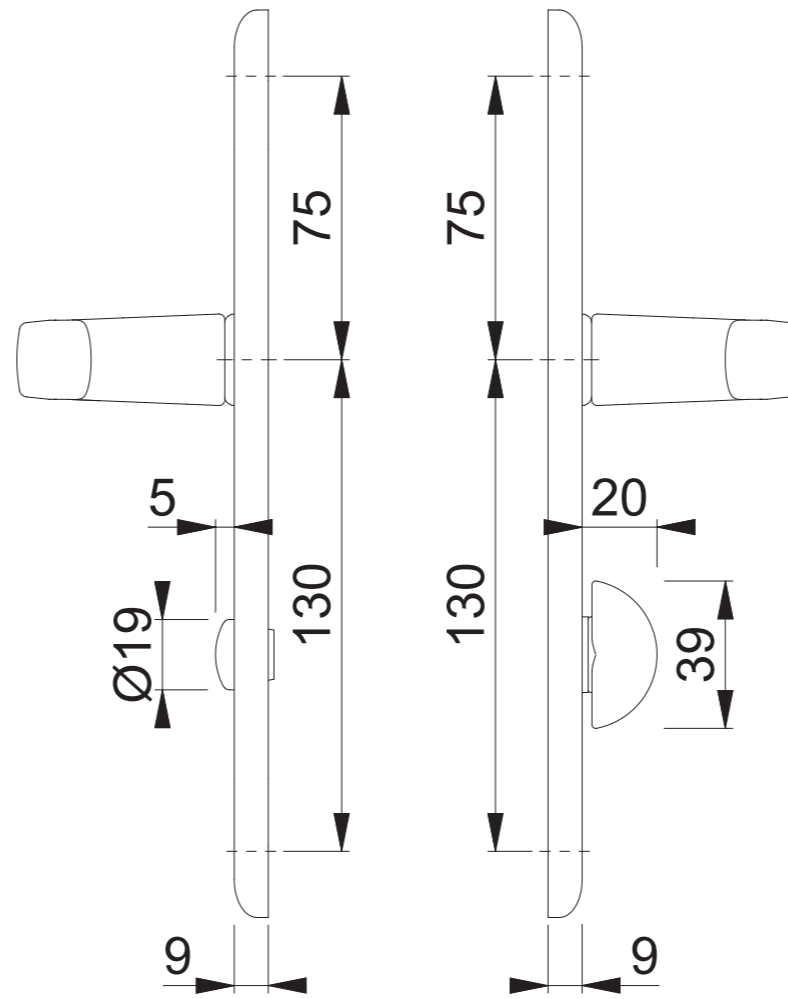
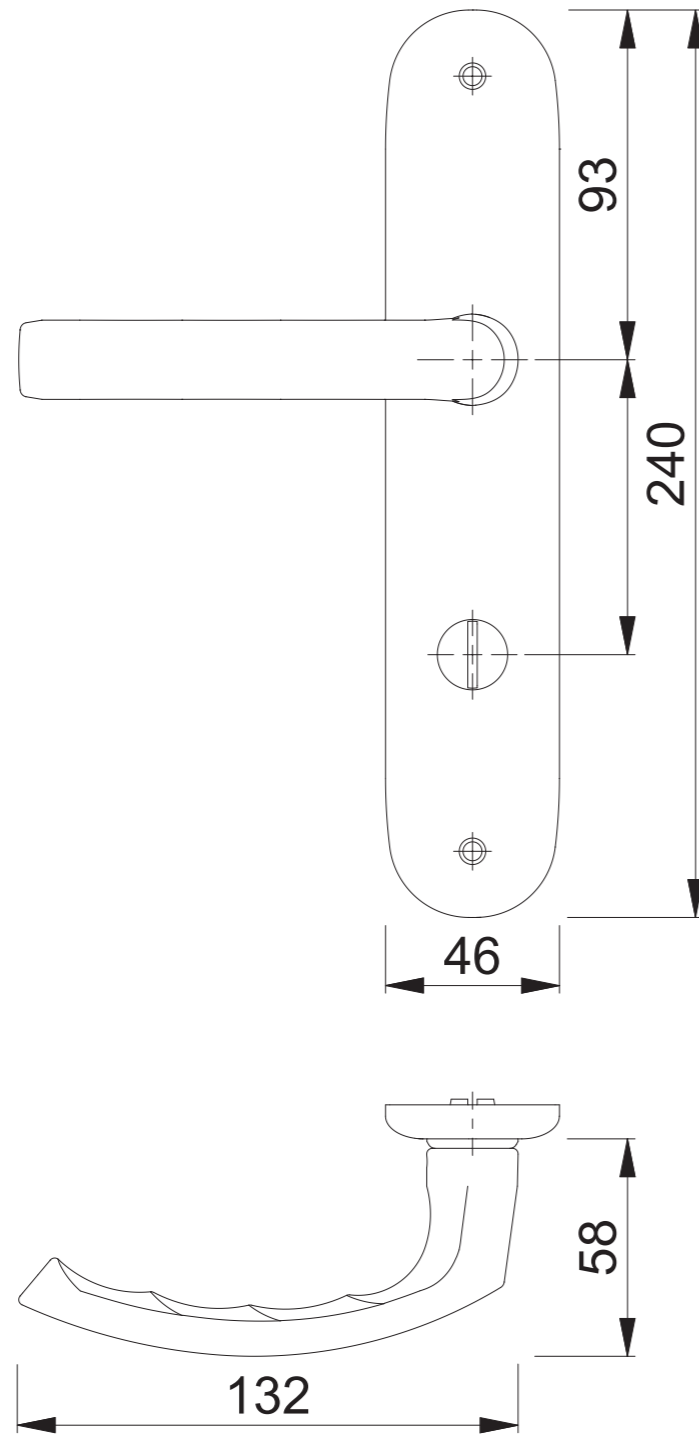

Maßstab 1:2	Name Scholz	Datum 20.09.2012	Zeichnungsnummer QU=c0022923z007 A300	HOPPE
----------------	----------------	---------------------	--	--------------