

1140/42FI

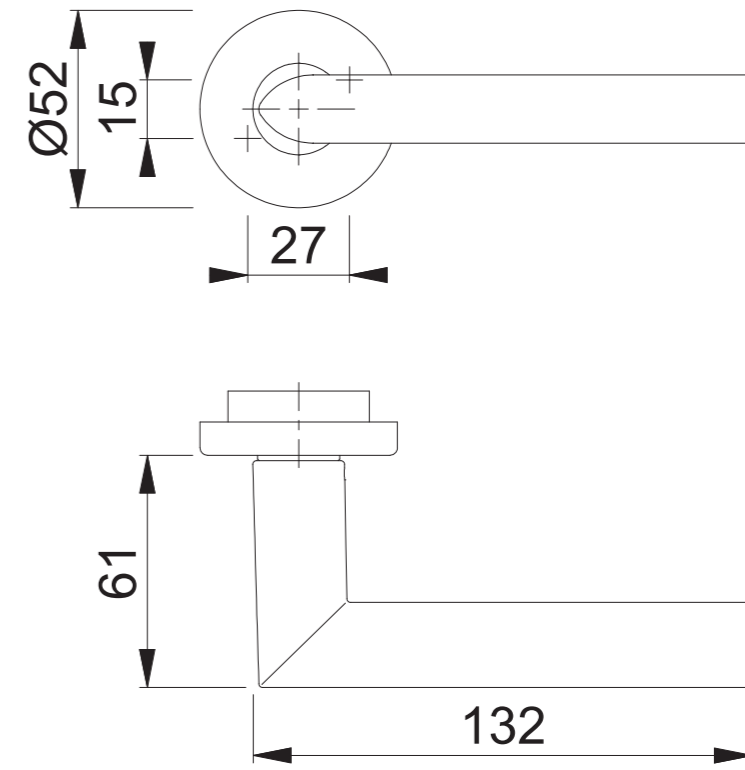

Maßstab	Name	Datum	Zeichnungsnummer
1:2	Scholz	27.11.2015	QU=c0023093z004 A3 00

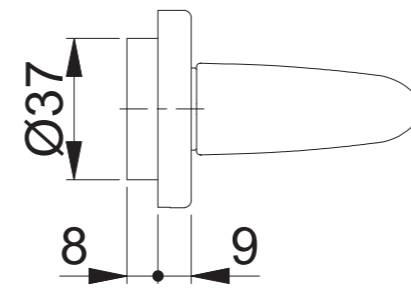
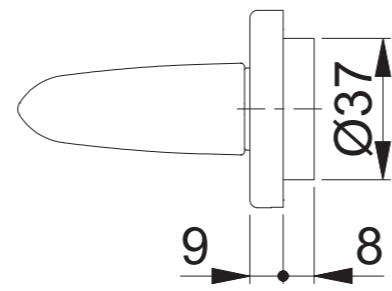
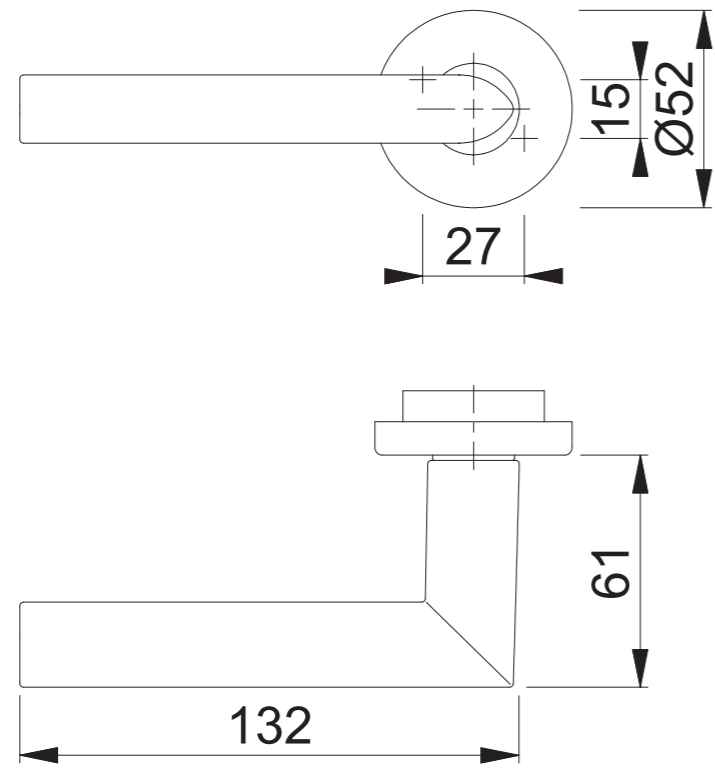