

1140/273P SK/OL (KSK27/OL92)

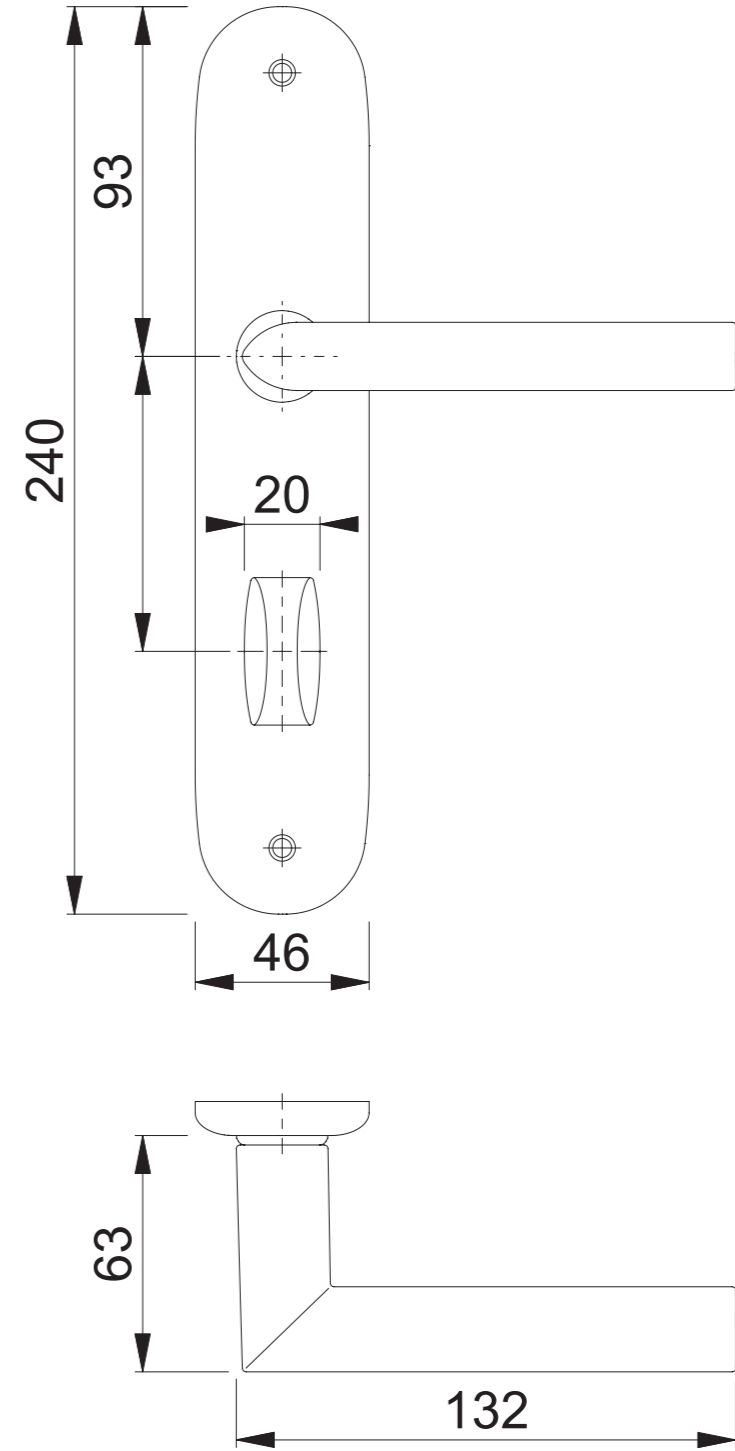

Maßstab 1:2	Name Scholz	Datum 20.09.2012	Zeichnungsnummer QU=c0022923z001 A300
----------------	----------------	---------------------	--

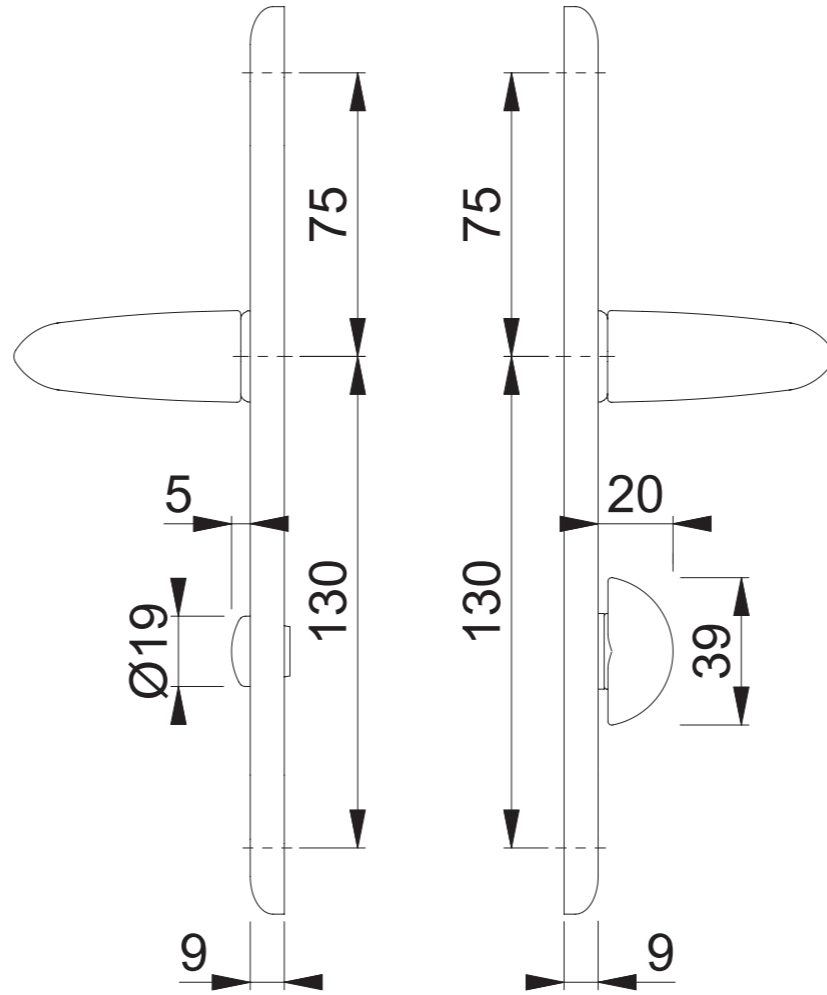
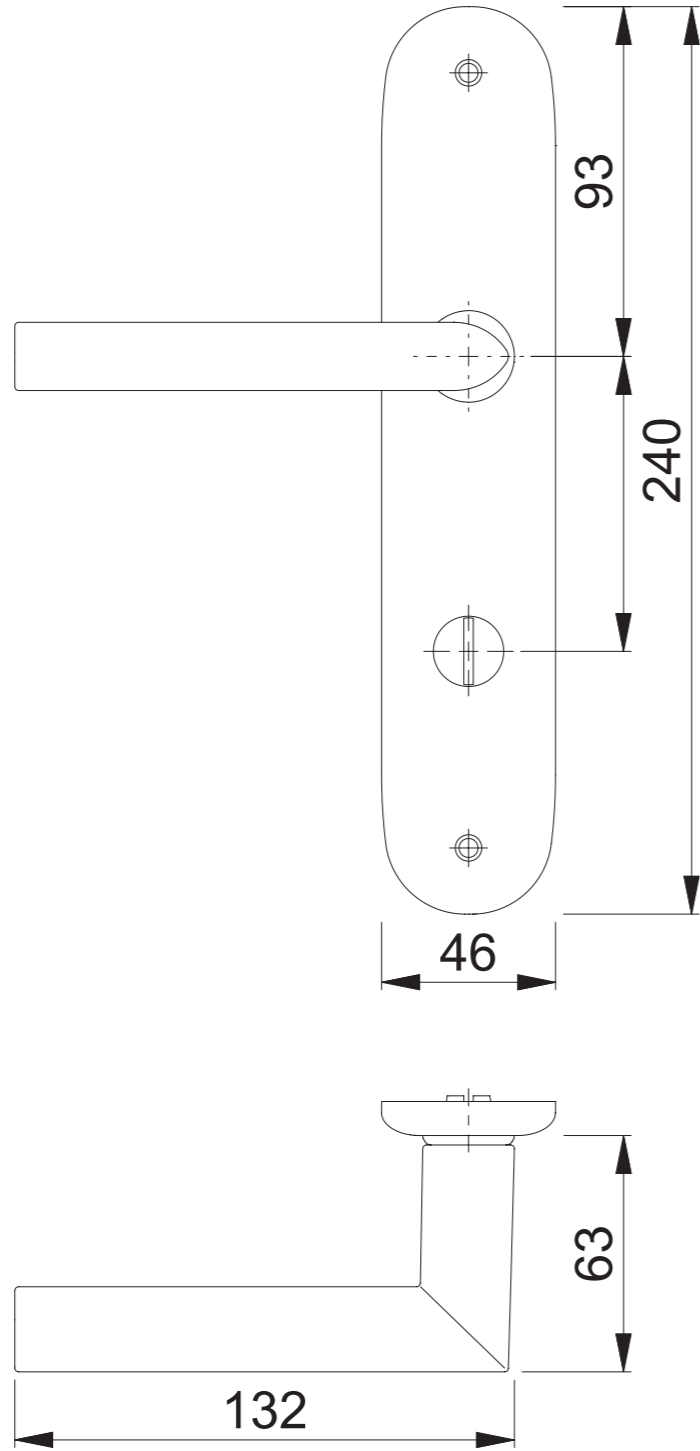